

# PRODUCT CATALOG

Laundry container, rolltainer® & more

Bonn 4.2



Landsberg XXL

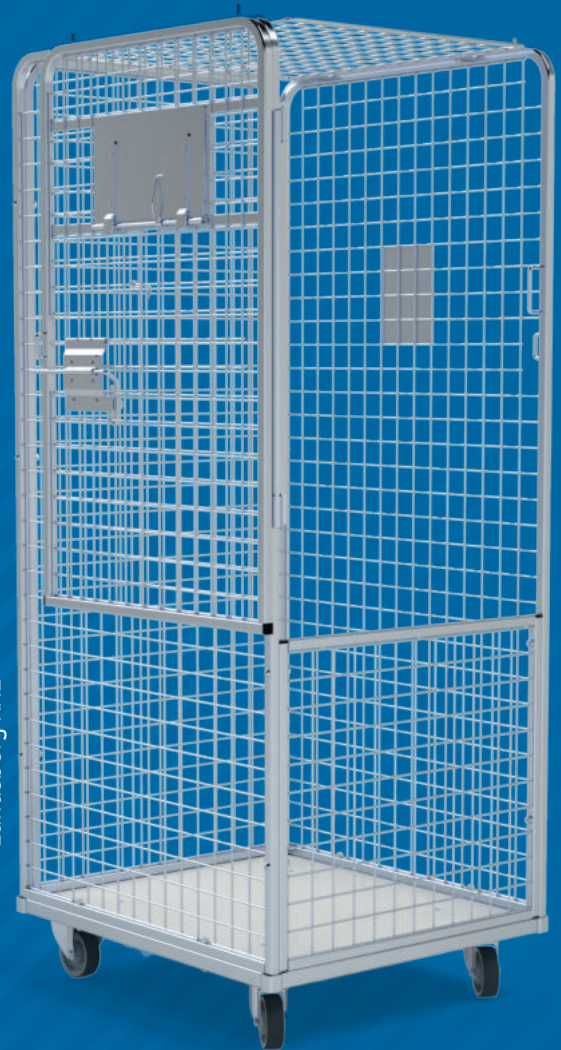

**Seewald**  
Transportgeräte



## CONTENTS

|                                    |    |
|------------------------------------|----|
| About Seewald Transportgeräte GmbH | 4  |
| General product information        | 5  |
| Laundry container                  | 6  |
| Laundry trolley                    | 30 |
| rolltainer®                        | 38 |
| nestainer®                         | 46 |
| Ball trolley                       | 52 |
| Accessories                        | 55 |
| Wheels & castors                   | 68 |





## SEEWALD TRANSPORTGERÄTE GMBH

Our family business Seewald Transportgeraete GmbH was founded in 2014 and is based in the marvelous Peiting, Bavaria. Our focus is on laundry and rolltainer®, but we are going one step further.

We complement our portfolio not only with different accessories, but also with extensions for a wide variety of applications. We do not stop with our high-quality products and additionally offer you individual and comprehensive advice. In addition, we are happy to produce special solutions for you according to your wishes and with our technical know-how. We are already passing on this knowledge to the 2nd generation.

Our goal is to be a competent partner for your company in order to offer you the best transport options and to make your work easier. That is why we are constantly improving our products. Your needs are what drives us. We look forward to work with you in the future.

## GENERAL PRODUCT INFORMATION

Our products are designed to offer the best cost-effectiveness. It is no problem, if the basic equipment does not suit your needs. All of our laundry and rolltainer® can be adapted and aligned to the given task area. If none of our standard containers are suitable for you, please contact us directly. We are happy to construct a custom-made product that is tailored to your needs. In addition, we offer you the option of individually embossing your new containers and labeling it with your company name, so that you immediately can see who the container belongs to. Just talk to us, together we will find the best solution. with us you move the progress in your company.

Our article names should make is easy for you to find the right product. We have developed a „code“ for this purpose, which we would like to explain briefly. In general, we talk about plastic, steel or wooden bottoms for laundry and rolltainer®. We use combinations of numbers and sizes to make it easier to distinguish the containers. Special features are in brackets ().

One of our premium and special models serves as an example:

| PRODUCT NAME          |                           |                                |                       |                                |                       | ARTICLE NUMBER    |         |         |         |       |        |                 |                                |                  |
|-----------------------|---------------------------|--------------------------------|-----------------------|--------------------------------|-----------------------|-------------------|---------|---------|---------|-------|--------|-----------------|--------------------------------|------------------|
| Premium               | I                         | S                              | 3.                    | 0                              | Steel Bottom          | W                 | P       | S       | 3.      | 600   | 740    | 1150            | B                              | 00000            |
| Name of the container | Variant of the base plate | Size of height                 | 3-sided               | Amount of intermediate shelves | Version of the bottom | Laundry container | Premium | Steel   | 3-sided | Width | Depth  | Height          | Blue galvanized                | Standard version |
| Bonn                  | 4.                        | 2                              | Steel Bottom          |                                |                       | W                 | S       | 4.      | 940     | 560   | 1760   | B               | 22                             | 000              |
| Name of the container | 4-sided                   | Amount of intermediate shelves | Version of the bottom |                                |                       | Laundry container | Steel   | 4-sided | Width   | Depth | Height | Blue galvanized | Amount of intermediate shelves | Standard castors |



## SWITZERLAND 5.2

With our Switzerland 5.2 laundry container, we present the absolute innovation as an alternative to cupboard trolleys and transport trolleys made from a mix of aluminium and plastic. Aluminium is used for the frame and provides the necessary stability. The privacy panels are made of plastic. This mix ensures that the trolley is neither too light nor too heavy and is easy to move. As a further extra, the Switzerland is equipped with our patented switching system and has a hinged lid and a double-leaf door. Another special feature is that the plastic panels can be replaced if damaged.

**Features:**

- 5-sided laundry container
- plastic plates and a frame made of aluminium
- 2 foldable intermediate shelves included
- color: anodized aluminium



More accessories and castor sets available.



Discover our switching system

|  | Switzerland 5.2 aluminium/plastic                                     |
|--|---|
| Article number   | WWK58506301750A2Z000  |
| Composition  | 5-sided   |
| Overall dimensions (B x T x H in mm)<br>Total height with Ø 100 mm castors | 875 x 650 x 1750 mm   |
| Internal dimensions (W x D x H mm)   | 810 x 600 x 1600 mm   |
| Payload  | 400 kg  |
| Weight   | 40 kg   |
| Mesh   | plastic plates and a frame made of aluminium                          |
| Shelves  | 2 foldable intermediate shelves included                              |
| Wheels   | 4 swivel castors, Ø 100 mm, TPE, ball bearing (with switching system) |
| Surface  | eloxiertes aluminium  |



## PREMIUM I 3.0

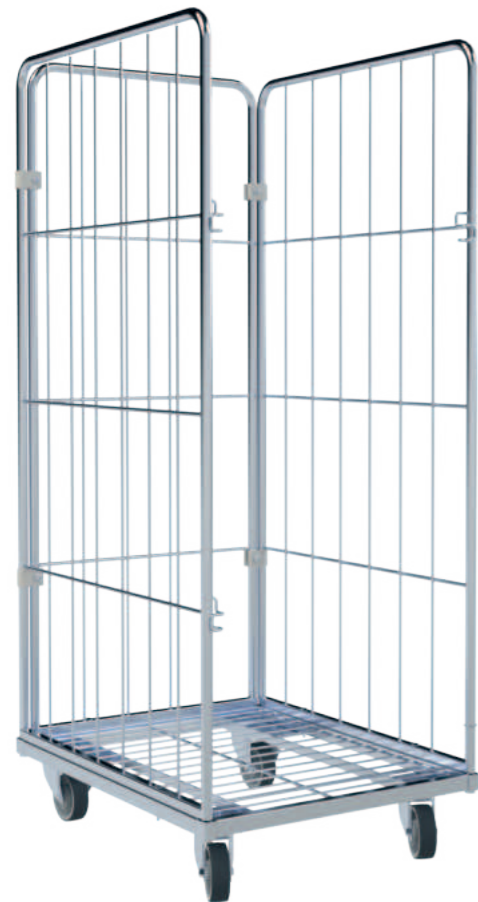

The 3-sided Premium I is available in three different heights and is equipped with smooth-running brand castors. Despite the smaller base plate, the laundry container has a very stable construction, which shows the high quality. The very good properties in the areas of comfort, handling and operation makes your daily work noticeably easier.

**Features:**

- 3-sided Premium I laundry container
- available in the heights 1150, 1350 and 1520 mm
- 2 swivel and 2 fixed castors, Ø 100 mm, TPR, ball bearing
- steel bottom
- color: blue galvanized



Also available with a plastic or wooden bottom, as well as further accessories and castor sets.

|  | Premium I S 3.0<br>Steel Bottom                                  | Premium I M 3.0<br>Steel Bottom | Premium I L 3.0<br>Steel Bottom                                  |
|--|--|---------------------------------|--|
| Article number   | WPS36007401150B00000   | WPS36007401350B00000            | WPS36007401520B00000   |
| Composition  | 3-sided  |                                 |  |
| Overall dimensions, W x D x H mm<br>Total height with Ø 100 mm castors | 600 x 740 x 1150   | 600 x 740 x 1350                | 600 x 740 x 1520   |
| Internal dimensions (W x D x H mm)                                     | 555 x 695 x 1000   | 555 x 695 x 1200                | 555 x 695 x 1370   |
| Payload  | 400 kg   |                                 |  |
| Weight   | 21 kg  | 22 kg                           | 24 kg  |
| Mesh   | round bar: 4/6 x vertical (Ø 6 mm),<br>2 x horizontal (Ø 7,8 mm) |                                 | round bar: 4/6 x vertical (Ø 6 mm),<br>3 x horizontal (Ø 7,8 mm) |
| Shelves  | optionally available   |                                 |  |
| Wheels   | 2 swivel and 2 fixed castors, Ø 100 mm, TPR, ball bearing        |                                 |  |
| Surface  | blue galvanized  |                                 |  |

## PREMIUM I 4.0



Our 4-sided version of the Premium I has the same advantages as the 3-sided version with the addition of a swivel-mounted front wall. In addition, the upper part of the front wall can be folded down to simplify loading and accessing the container. To be expanded for example, the Premium I can be equipped with document frames and many more.

**Features:**

- same as Premium I 3.0 (page 8)
- 4-sided Premium I laundry container
- additionally with a foldable & swivel-mounted door
- expandable with intermediate shelves, document frames, bumper wheels and many more



Also available with a plastic or wooden bottom, as well as further accessories and castor sets.

|  | Premium I S 4.0<br>Steel Bottom                                  | Premium I M 4.0<br>Steel Bottom | Premium I L 4.0<br>Steel Bottom                                    |
|--|--|---------------------------------|--|
| Article number   | WPS46007401150B00000   | WPS46007401350B00000            | WPS46007401520B00000   |
| Composition  | 4-sided  |                                 |  |
| Overall dimensions, W x D x H mm<br>Total height with Ø 100 mm castors | 600 x 740 x 1150   | 600 x 740 x 1350                | 600 x 740 x 1520   |
| Internal dimensions (W x D x H mm)                                     | 555 x 695 x 1000   | 555 x 695 x 1200                | 555 x 695 x 1370   |
| Payload  | 400 kg   |                                 |  |
| Weight   | 25 kg  | 27 kg                           | 29 kg  |
| Mesh   | round bar: 4/6 x vertical (Ø 6 mm),<br>2 x horizontal (Ø 7,8 mm) |                                 | round bar: 4/6 x vertical (Ø 6 mm),<br>2/3 x horizontal (Ø 7,8 mm) |
| Shelves  | optionally available   |                                 |  |
| Wheels   | 2 swivel and 2 fixed castors, Ø 100 mm, TPR, ball bearing        |                                 |  |
| Surface  | blue galvanized  |                                 |  |



## PREMIUM II 3.0

Our laundry container **Premium II** is available in four different heights with our 3-sided version. The smoothrunning brand castors under the middle base plate move the solid construction safely through your company. The smaller mesh, compared to the Basic model, increases the stability and quality. On request, the plastic bottom can be exchanged against a steel or wooden bottom.

### Features:

- 3-sided Premium II laundry container
- available in the heights 1350, 1520 and 1700 mm
- 2 swivel and 2 fixed castors, Ø 100 mm, TPR, ball bearing
- plastic bottom
- maximum usable height 1550 mm (size XL)
- color: blue galvanized



Also available with a plastic or wooden bottom, as well as further accessories and castor sets.

|  | Premium II M 3.0<br>Plastic Bottom                               | Premium II L 3.0<br>Plastic Bottom                                 | Premium II XL 3.0<br>Plastic Bottom |
|--|--|--|-------------------------------------|
| Article number   | WPK36008101350<br>B00000   | WPK36008101520<br>B00000   | WPK36008101700<br>B00000            |
| Composition  | 3-sided  |  |                                     |
| Overall dimensions, W x D x H mm<br>Total height with Ø 100 mm castors | 600 x 810 x 1350   | 600 x 810 x 1520   | 600 x 810 x 1700                    |
| Internal dimensions (W x D x H mm)                                     | 555 x 765 x 1200   | 555 x 765 x 1370   | 555 x 765 x 1550                    |
| Payload  | 400 kg   |  |                                     |
| Weight   | 24 kg  | 25,5 kg  | 27 kg                               |
| Mesh   | round bar: 4/6 x vertical (Ø 6 mm),<br>2 x horizontal (Ø 7,8 mm) | round bar: 4/6 x vertical (Ø 6 mm),<br>2/3 x horizontal (Ø 7,8 mm) |                                     |
| Shelves  | optionally available   |  |                                     |
| Wheels   | 2 swivel and 2 fixed castors, Ø 100 mm, TPR, ball bearing        |  |                                     |
| Surface  | blue galvanized  |  |                                     |



## PREMIUM II 4.0

With our 4-sided version, the front wall comes additionally, which is swivel-mounted and the upper part can be folded down. You are welcome to expand the basic equipment with intermediate shelves or our innovative switching system, which converts the two swivel castors into two fixed castors with just one „click“.

### Features:

- same as Premium II 3.0 (page 10)
- 4-sided Premium II laundry container
- additionally with a foldable & swivel-mounted door
- expandable with our innovative switching system



Also available with a plastic or wooden bottom, as well as further accessories and castor sets.

|  | Premium II M 4.0<br>Steel Bottom                                 | Premium II L 4.0<br>Steel Bottom                                   | Premium II XL 4.0<br>Steel Bottom |
|--|--|--|-----------------------------------|
| Article number   | WPS46008101350<br>B00000   | WPS46008101520<br>B00000   | WPS46008101700<br>B00000          |
| Composition  | 4-sided  |  |                                   |
| Overall dimensions, W x D x H mm<br>Total height with Ø 100 mm castors | 600 x 810 x 1350   | 600 x 810 x 1520   | 600 x 810 x 1700                  |
| Internal dimensions (W x D x H mm)                                     | 555 x 765 x 1200   | 555 x 765 x 1370   | 555 x 765 x 1550                  |
| Payload  | 400 kg   |  |                                   |
| Weight   | 28 kg  | 30 kg  | 32 kg                             |
| Mesh   | round bar: 4/6 x vertical (Ø 6 mm),<br>2 x horizontal (Ø 7,8 mm) | round bar: 4/6 x vertical (Ø 6 mm),<br>2/3 x horizontal (Ø 7,8 mm) |                                   |
| Shelves  | optionally available   |  |                                   |
| Wheels   | 2 swivel and 2 fixed castors, Ø 100 mm, TPR, ball bearing        |  |                                   |
| Surface  | blue galvanized  |  |                                   |



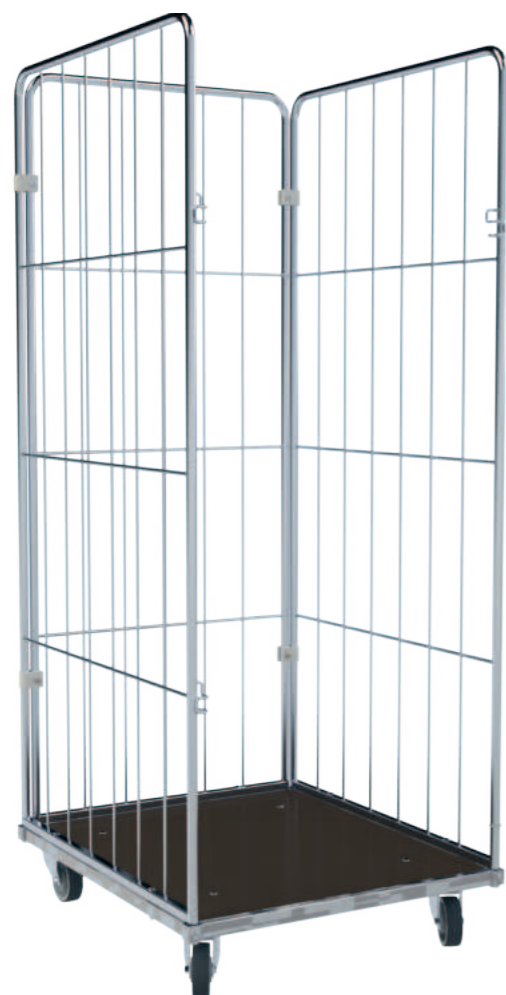

### PREMIUM III 3.0

The 3-sided laundry container **Premium III** is available in five different heights and features smooth-running brand castors. with a basic dimension of 720 x 810 mm and a maximum height of 1800 mm it has a large capacity. The closed wooden bottom on the large base plate is very robust and therefore suitable for many possible applications. Due to the size and stability the user can do the work easy and safe.

**Features:**

- 3-sided Premium III laundry container
- available in the heights 1150, 1350, 1520, 1700 and 1800 mm
- 2 swivel and 2 fixed castors, Ø 100 mm, TPR, ball bearing
- up to 400 kg load capacity
- wooden bottom
- color: blue galvanized



Also available with a steel or plastic bottom, as well as further accessories and castor sets.

|  | Premium III S 3.0<br>Wooden Bottom                               | Premium III M 3.0<br>Wooden Bottom | Premium III L 3.0<br>Wooden Bottom                               | Premium III XL 3.0<br>Wooden Bottom | Premium III XXL 3.0<br>Wooden Bottom |
|--|--|------------------------------------|--|-------------------------------------|--------------------------------------|
| Article number   | WPH37208101150<br>B00000   | WPH37208101350<br>B00000           | WPH37208101520<br>B00000   | WPH37208101700<br>B00000            | WPH37208101800<br>B00000             |
| Composition  | 3-sided  |                                    |  |                                     |                                      |
| Overall dimensions*<br>Total height with<br>Ø 100 mm castors | 720 x 810 x 1150   | 720 x 810 x 1350                   | 720 x 810 x 1520   | 720 x 810 x 1700                    | 720 x 810 x 1800                     |
| InnenDimension*  | 675 x 765 x 1000   | 675 x 765 x 1200                   | 675 x 765 x 1370   | 675 x 765 x 1550                    | 675 x 765 x 1650                     |
| Payload  | 400 kg   |                                    |  |                                     |                                      |
| Weight   | 23 kg  | 25 kg                              | 26 kg  | 28 kg                               | 28,5 kg                              |
| Mesh   | round bar: 5/6 x vertical (Ø 6 mm),<br>2 x horizontal (Ø 7,8 mm) |                                    | round bar: 5/6 x vertical (Ø 6 mm),<br>3 x horizontal (Ø 7,8 mm) |                                     |                                      |
| Shelves  | optionally available   |                                    |  |                                     |                                      |
| Wheels   | 2 swivel and 2 fixed castors, Ø 100 mm, TPR, ball bearing        |                                    |  |                                     |                                      |
| Surface  | blue galvanized  |                                    |  |                                     |                                      |

\*Overall dimensions (W x D x H mm)



### PREMIUM III 4.0

Our flagship **Premium III** is also available in 4-sided versions and adds a swivel-mounted front wall, the top of which can be folded down halfway. The advantages of the 3-sided version have also been adopted and enables a comfortable working day. This container can be complemented with accessories, such as our bumper wheels or a cover good that protects the container.

**Features:**

- same as Premium III 3.0 (page 12)
- 4-sided Premium III laundry container
- additionally with a foldable & swivel-mounted door
- expandable with four bumper wheels and cover hood



Also available with a steel or plastic bottom, as well as further accessories and castor sets.

|  | Premium III S 4.0<br>Wooden Bottom                               | Premium III M 4.0<br>Wooden Bottom | Premium III L 4.0<br>Wooden Bottom                                 | Premium III XL 4.0<br>Wooden Bottom | Premium III XXL 4.0<br>Wooden Bottom |
|--|--|------------------------------------|--|-------------------------------------|--------------------------------------|
| Article number   | WPH47208101150<br>B00000   | WPH47208101350<br>B00000           | WPH47208101520<br>B00000   | WPH47208101700<br>B00000            | WPH47208101800<br>B00000             |
| Composition  | 4-sided  |                                    |  |                                     |                                      |
| Overall dimensions*<br>Total height with<br>Ø 100 mm castors | 720 x 810 x 1150   | 720 x 810 x 1350                   | 720 x 810 x 1520   | 720 x 810 x 1700                    | 720 x 810 x 1800                     |
| InnenDimension*  | 675 x 765 x 1000   | 675 x 765 x 1200                   | 675 x 765 x 1370   | 675 x 765 x 1550                    | 675 x 765 x 1650                     |
| Payload  | 400 kg   |                                    |  |                                     |                                      |
| Weight   | 29 kg  | 31 kg                              | 33 kg  | 35 kg                               | 36 kg                                |
| Mesh   | round bar: 5/6 x vertical (Ø 6 mm),<br>2 x horizontal (Ø 7,8 mm) |                                    | round bar: 5/6 x vertical (Ø 6 mm),<br>2/3 x horizontal (Ø 7,8 mm) |                                     |                                      |
| Shelves  | optionally available   |                                    |  |                                     |                                      |
| Wheels   | 2 swivel and 2 fixed castors, Ø 100 mm, TPR, ball bearing        |                                    |  |                                     |                                      |
| Surface  | blue galvanized  |                                    |  |                                     |                                      |

\*Overall dimensions (W x D x H mm)



## BONN 4.2

Our **Bonn** offers a smart 2-in-1 system. Thanks to the foldable intermediate shelves the laundry container can be used both for the transport of dirty and clean laundry and therefore offers an optimal solution for both applications. The lower level is protected by a short front wall. The Bonn adds a useful value due to the supplied clothes rail.

### Features:

- 4-sided Bonn laundry container
- 4 bumper wheels
- 2 fixed mounted & foldable intermediate shelves
- fixed mounted, short front wall
- 2 swivel and 2 fixed castors, Ø 100 mm, TPR, ball bearing
- clothes rail



Discover our switching system



## BONN 4.2 with drawbar and coupling system

This version of the **Bonn** expands the application of the already existing 2-in-1 system. In addition to the usual option of folding the intermediate shelves to a front wall, now this container also comes with a coupling and drawbar. This makes it possible to couple and pull a total of 3 container in a row. Therefore a larger amount of laundry can be transported over much longer distance. In addition, there is a metal sheet measuring 300x340 mm on the left side wall that can be painted with blackboard lacquer on request.

### Features:

- incl. coupling & drawbar (to couple up to 3 containers)
- metal sheet measuring 300 x 400 mm (blackboard lacquer on request)
- 4 bumper wheels
- 2 fixed mounted & foldable intermediate shelves
- fixed mounted, short front wall
- 2 swivel and 2 fixed castors Ø 125 mm TPE, ball bearing
- clothes rail



Also available with a plastic or wooden bottom, as well as further accessories and castor sets.

|  | Bonn 4.2<br>Steel Bottom   |
|--|--|
| Article number   | WS49405601740B2Z000  |
| Composition  | 4-sided  |
| Overall dimensions, W x D x H mm<br>Total height with Ø 100 mm castors | 940 x 560 x 1740   |
| Internal dimensions (W x D x H mm)                                     | 900 x 520 x 1590   |
| Payload  | 400 kg   |
| Weight   | 45,2 kg  |
| Mesh   | round bar: 6/8 x vertical (Ø 6 mm),<br>1/4 x horizontal (Ø 7,8 mm) |
| Shelves  | 2 shelves included   |
| Wheels   | 2 swivel and 2 fixed castors, Ø 100 mm, TPR, ball bearing          |
| Surface  | blue galvanized  |

|  | Bonn 4.2 Steel Bottom<br>with drawbar and coupling system          |
|--|--|
| Article number   | WS49405601765B2ZKD10   |
| Composition  | 4-sided  |
| Overall dimensions, W x D x H mm<br>Total height with Ø 100 mm castors | 940 x 560 x 1740   |
| Internal dimensions (W x D x H mm)                                     | 900 x 520 x 1765   |
| Payload  | 400 kg   |
| Weight   | 48 kg  |
| Mesh   | round bar: 6/8 x vertical (Ø 6 mm),<br>1/4 x horizontal (Ø 7,8 mm) |
| Shelves  | 2 shelves included   |
| Wheels   | 2 swivel and 2 fixed castors, Ø 125 mm, TPR, ball bearing          |
| Surface  | blue galvanized  |





## BERN 3.2

The **Bern** is equipped with two permanently mounted intermediate shelves, which are foldable to the inside. Therefore it is possible to fill the container on all three levels, due to the wide front. By this smart 2-in-1 system transport is given for dirty and also clean laundry. In addition, the four bumper wheels create an ideal protection on walls or other rolltainer®. Through the additional use of plastic spacer castors the laundry container runs with reduced background noise. You will also receive a label board for a better assignment as well as a tread plate.

### Features:

- 4-sided Bonn laundry container
- 4 bumper wheels
- 2 fixed mounted & foldable intermediate shelves
- fixed mounted, short front wall
- 2 swivel and 2 fixed castors, Ø 100 mm, TPR, ball bearing
- clothes rail



Also available with a steel or wooden bottom, as well as further accessories and castor sets.

|  | Bern 3.2<br>Plastic Bottom   |
|--|--|
| Article number   | WWK38506301750B2Z000   |
| Composition  | 3-sided  |
| Overall dimensions, W x D x H mm<br>Total height with Ø 100 mm castors | 850 x 630 x 1750   |
| Internal dimensions (W x D x H mm)                                     | 805 x 590 x 1600   |
| Payload  | 500 kg   |
| Weight   | 40 kg  |
| Mesh   | round bar: 5/6 x vertical (Ø 6 mm),<br>3/4 x horizontal (Ø 7,8 mm) |
| Shelves  | 2 shelves included   |
| Wheels   | 2 swivel and 2 fixed castors, Ø 100 mm, TPR, ball bearing          |
| Surface  | blue galvanized  |



## BERN 3.2.2

In essence, the **Bern 3.2.2** remains unchanged compared to the Bern 3.2. The difference between these models can be found in the upper shelf, which can be folded back in this version. The lower shelf can still be folded forward to prevent the content from falling out. The advantage here is that it is easier to access the contents of the container, e. g. the clothes rail can be optimally used.

### Features:

- 3-sided container
- 2 fixed mounted & foldable intermediate shelves included, the upper shelf can be folded to the rear wall
- 2 swivel and 2 fixed castors, Ø 100 mm, TPE, ball bearing
- payload up to 500 kg
- 4 bumper wheels
- label board
- tread plate
- smart 2-in-1 system



Also available with a plastic or wooden bottom, as well as further accessories and castor sets.

|  | Bern 3.2.2<br>Steel Bottom   |
|--|--|
| Article number   | WWS38506301750B2Z200   |
| Composition  | 3-sided  |
| Overall dimensions, W x D x H mm<br>Total height with Ø 100 mm castors | 850 x 630 x 1750   |
| Internal dimensions (W x D x H mm)                                     | 805 x 590 x 1600   |
| Payload  | 500 kg   |
| Weight   | 40 kg  |
| Mesh   | round bar: 5/6 x vertical (Ø 6 mm),<br>3/4 x horizontal (Ø 7,8 mm) |
| Shelves  | 2 shelves included, the upper shelf can be folded to the rear wall |
| Wheels   | 2 swivel and 2 fixed castors, Ø 100 mm, TPR, ball bearing          |
| Surface  | blue galvanized  |



## SULINGEN 3.2

With a base of 825 x 738 mm our laundry container **Sulingen 3.2** is ideal for your business. Two integrated intermediate shelves make it possible to transport clean laundry to its destination in an organized manner. If required, you can fold the intermediate shelves back and get plenty of space for e.g. dirty laundry.

**Features:**

- 3-sided laundry container
- 2 swivel and 2 fixed castors, Ø 100 mm, TPR, ball bearing
- 2 foldable intermediate shelves included
- plastic, steel or wooden bottom
- color: blue galvanized



More accessories and castor sets available.

|  | Sulingen 3.2<br>Steel Bottom   | Sulingen 3.2<br>Plastic Bottom | Sulingen 3.2<br>Wooden Bottom |
|--|--|--------------------------------|-------------------------------|
| Article number   | WSS38257371710B2Z000   | WSK38257371710B2Z000           | WSH38257371710B2Z000          |
| Composition  | 3-sided  |                                |                               |
| Overall dimensions, W x D x H mm<br>Total height with Ø 100 mm castors | 825 x 738 x 1710 mm  |                                |                               |
| Internal dimensions (W x D x H mm)                                     | 755 x 685 x 1550 mm  |                                |                               |
| Payload  | 500 kg   |                                |                               |
| Weight   | 43 kg  | 43,5 kg                        | 43,8 kg                       |
| Mesh   | round bar: 8 x vertical (Ø 6 mm),<br>oval tube: 3 x horizontal (Ø 15 mm) |                                |                               |
| Shelves  | 2 shelves included   |                                |                               |
| Wheels   | 2 swivel and 2 fixed castors, Ø 100 mm, TPR, ball bearing                |                                |                               |
| Surface  | blue galvanized  |                                |                               |



## WEIMAR 4.2

Our laundry container **Weimar 4.2** comes with two integrated intermediate shelves and a clothes rail. A small fixed front panel offers basic protection against goods falling out. This protective edge can be conveniently extended by folding the first intermediate shelf forwards. To ease the loading or to enable the transport of dresses, the second intermediate shelf can be folded back so that the clothes rail can be used.

**Features:**

- 4-sided laundry container
- 2 swivel and 2 fixed castors, Ø 100 mm, TPR, ball bearing
- 2 foldable intermediate shelves included
- plastic, steel or wooden bottom
- color: blue galvanized



More accessories and castor sets available.

|  | Weimar 4.2<br>Steel Bottom   | Weimar 4.2<br>Plastic Bottom | Weimar 4.2<br>Wooden Bottom |
|--|--|------------------------------|-----------------------------|
| Article number   | WWS48756751738B2Z000   | WWK48756751738B2Z000         | WWH48756751738B2Z000        |
| Composition  | 4-sided  |                              |                             |
| Overall dimensions, W x D x H mm<br>Total height with Ø 100 mm castors | 875 x 675 x 1710 mm  |                              |                             |
| Internal dimensions (W x D x H mm)                                     | 760 x 625 x 1550 mm  |                              |                             |
| Payload  | 500 kg   |                              |                             |
| Weight   | 47 kg  | 47,5 kg                      | 47,8 kg                     |
| Mesh   | round bar: 7/9 x vertical (Ø 6 mm),<br>oval tube: 3/4 x horizontal (Ø 15 mm) |                              |                             |
| Shelves  | 2 shelves included   |                              |                             |
| Wheels   | 2 swivel and 2 fixed castors, Ø 100 mm, TPR, ball bearing                    |                              |                             |
| Surface  | blue galvanized  |                              |                             |





## BASIC I

The **Basic I** is available as a 3- or 4-sided version. The basic model, which exists in two different heights, offers the most important basic functions for your company. The small base plate allows an excellent navigation even in narrow aisles and is also available with a steel or plastic bottom. Of course the laundry container can be expanded with matching accessories.

### Features:

- 3- or 4-sided Basic I laundry container
- available in the heights 1520 and 1730 mm
- 2 swivel and 2 fixed castors, Ø 100 mm, TPR, ball bearing
- foldable & swivel-mounted door (4-sided)
- wooden bottom



Also available with a steel or plastic bottom, as well as further accessories and castor sets.

|   | Basic I M 3.0<br>Wooden Bottom                              | Basic I L 3.0<br>Wooden Bottom | Basic I M 4.0<br>Wooden Bottom | Basic I L 4.0<br>Wooden Bottom |
|---|---|--------------------------------|--------------------------------|--------------------------------|
| Article number  | WBH36007201520<br>B00000                                    | WBH36007201730<br>B00000       | WBH46007201520<br>B00000       | WBH46007201730<br>B00000       |
| Composition   | 3-sided   |                                | 4-sided                        |                                |
| Overall dimensions (B x T x H mm)<br>Total height with Ø 100 mm castors | 600 x 720 x 1520  | 600 x 720 x 1730               | 600 x 720 x 1520               | 600 x 720 x 1730               |
| Internal dimensions (W x D x H mm)                                      | 555 x 675 x 1370  | 555 x 675 x 1580               | 555 x 675 x 1370               | 555 x 675 x 1580               |
| Payload   | 400 kg  |                                |                                |                                |
| Weight  | 26,5 kg   | 29 kg                          | 31 kg                          | 34 kg                          |
| Mesh  | Round bar: 4 x vertical (Ø 6 mm), 2 x horizontal (Ø 7,8 mm) |                                |                                |                                |
| Shelves   | optionally available  |                                |                                |                                |
| Wheels  | 2 swivel and 2 fixed castors, Ø 100 mm, TPR, ball bearing   |                                |                                |                                |
| Surface   | blue galvanized   |                                |                                |                                |



## LANDSBERG XXL 5.0

Do you need a 5-sided container? Then our laundry container **Landsberg XXL 5.0** is a good choice. The tightly meshed panels prevent the clothes from falling out. The flap in the front panel is used for loading. The high-quality castors offer a high level of comfort on many floors.

### Features:

- 5-sided laundry container
- 2 swivel and 2 fixed castors, Ø 100 mm, TPR, ball bearing
- plastic, steel or wooden bottom
- made of square tube
- secure storage due to 50 x 50 mm mesh
- color: blue galvanized



More accessories and castor sets available.

|  | Landsberg XXL 5.0<br>Steel Bottom                         | Landsberg XXL 5.0<br>Plastic Bottom | Landsberg XXL 5.0<br>Wooden Bottom |
|--|---|-------------------------------------|------------------------------------|
| Article number   | WAS57008001840B00000                                      | WAK57008001840B00000                | WAH57008001840B00000               |
| Composition  | 5-sided   |                                     |                                    |
| Overall dimensions, W x D x H mm<br>Total height with Ø 100 mm castors | 710 x 810 x 1860 mm                                       |                                     |                                    |
| Internal dimensions (W x D x H mm)                                     | 660 x 760 x 1660 mm                                       |                                     |                                    |
| Payload  | 500 kg  |                                     |                                    |
| Weight   | 52 kg   | 52,5 kg                             | 52,8 kg                            |
| Mesh   | wire infill 50 x 50 mm, Ø 3,8 mm                          |                                     |                                    |
| Shelves  | not available   |                                     |                                    |
| Wheels   | 2 swivel and 2 fixed castors, Ø 100 mm, TPR, ball bearing |                                     |                                    |
| Surface  | blue galvanized   |                                     |                                    |

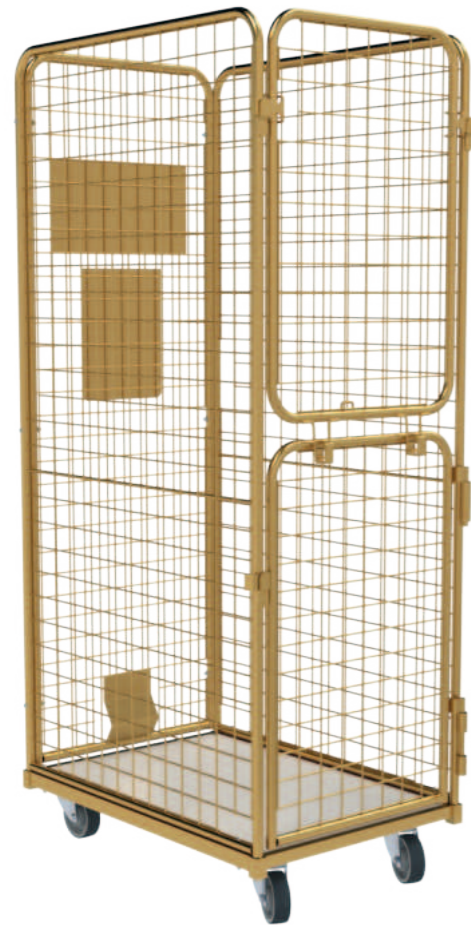

### AUSTRIA XL 4.0

Our laundry container **Austria XL 4.0** is an exception among our containers thanks to its yellow galvanizing. With its fixed mounted front panel and the tightly meshed grating, it guarantees safe transportation of the laundry to the desired destination. Optionally you can receive our laundry container with a plastic or wooden bottom.

**Features:**

- 4-sided laundry container
- 2 swivel and 2 fixed castors, Ø 100 mm, TPR, ball bearing
- plastic or wooden bottom
- color: yellow galvanized



More accessories and castor sets available.

|  | Austria XL 4.0<br>Plastic Bottom                          | Austria XL 4.0<br>Wooden Bottom |
|--|---|---------------------------------|
| Article number   | WGK45608001700B00000                                      | WGH45608001700B00000            |
| Composition  | 4-sided   |                                 |
| Overall dimensions, W x D x H mm<br>Total height with Ø 125 mm castors | 560 x 810 x 1710 mm                                       |                                 |
| Internal dimensions (W x D x H mm)                                     | 495 x 750 x 1540 mm                                       |                                 |
| Payload  | 400 kg  |                                 |
| Weight   | 38 kg   | 38,5 kg                         |
| Mesh   | wire infill 50 x 50 mm, Ø 3,8 mm                          |                                 |
| Shelves  | not available   |                                 |
| Wheels   | 2 swivel and 2 fixed castors, Ø 100 mm, TPR, ball bearing |                                 |
| Surface  | yellow galvanized   |                                 |



### WUPPERTAL 3.3

Robust, practical and flexible – that is our **Wuppertal 3.3** laundry container. The three fixed intermediate shelves can be folded forwards and - when folded - turn the 3-sided laundry container with 3 intermediate shelves into a 4-sided laundry container without intermediate shelves. This allows you to transport clean or dirty laundry flexibly and conveniently. The Wuppertal 3.3 is also equipped with a clothes rail.

**Features:**

- 3-sided laundry container
- 2 swivel and 2 fixed castors, Ø 100 mm, TPR, ball bearing
- 3 foldable intermediate shelves included
- color: blue galvanized



More accessories and castor sets available.

|  | Wuppertal 3.3<br>Steel Bottom                               |
|--|---|
| Article number   | RWS311905101600B00000                                       |
| Composition  | 3-sided   |
| Overall dimensions, W x D x H mm<br>Total height with Ø 100 mm castors | 1185 x 503 x 1646 mm  |
| Internal dimensions (W x D x H mm)                                     | 1140 x 478 x 1430 mm  |
| Payload  | 400 kg  |
| Weight   | 46,2 kg   |
| Mesh   | round bar: 8 x vertical (Ø 6 mm), 3 x horizontal (Ø 7,8 mm) |
| Shelves  | 3 shelves included  |
| Wheels   | 2 swivel and 2 fixed castors, Ø 100 mm, TPR, ball bearing   |
| Surface  | blue galvanized   |





## BREMEN 4.0

Due to its two-part front, the **Bremen** is 4-sided and enables the upper half to be folded. Even when closed, the container can be filled very comfortably due to the shortened front. With a base plate of 850 x 630 mm sufficient capacity is provided. The build-in bumper wheels protect walls as well as other rolltainer®. Additionally the bumper wheels lead to an increased service life of the laundry bags.

### Features:

- 4-sided laundry container
- 2 swivel and 2 fixed castors, Ø 100 mm, TPR, ball bearing
- foldable door
- closed PVC bottom
- color: blue galvanized



Also available with a steel or wooden bottom, as well as further accessories and castor sets.



## HALLE XXL 4.0

Our largest laundry container, **Halle XXL**, has a huge amount of space and a load capacity of up to 600 kg. Our container Halle XXL comes with a foldable and swivel-mounted door and can be extended with intermediate shelves which you can easily position to your needs due to the tight mesh of the container.

### Features:

- 4-sided laundry container
- 2 swivel and 2 swivel castors with brakes, Ø 125 mm, elastic (grey), ball bearing
- up to 600 kg load capacity
- foldable & swivel-mounted door
- possible intermediate shelves implementable individually
- stable construction



More accessories and castor sets available.

|  | Bremen 4.0<br>Plastic Bottom                                       |
|--|--|
| Article number   | WSK48506301750B00000   |
| Composition  | 4-sided  |
| Overall dimensions, W x D x H mm<br>Total height with Ø 100 mm castors | 850 x 630 x 1750   |
| Internal dimensions (W x D x H mm)                                     | 805 x 590 x 1600   |
| Payload  | 500 kg   |
| Weight   | 42,8 kg  |
| Mesh   | round bar: 7/9 x vertical (Ø 6 mm),<br>3/4 x horizontal (Ø 7,8 mm) |
| Shelves  | not available  |
| Wheels   | 2 swivel and 2 fixed castors, Ø 100 mm, TPR, ball bearing          |
| Surface  | blue galvanized  |

|  | Halle XXL 4.0<br>Steel Bottom   |
|--|---|
| Article number   | S48001200FC053  |
| Composition  | 4-sided   |
| Overall dimensions, W x D x H mm<br>Total height with Ø 125 mm castors | 1200 x 800 x 1820   |
| Internal dimensions (W x D x H mm)                                     | 1150 x 750 x 1605   |
| Payload  | 600 kg  |
| Weight   | 66,3 kg   |
| Mesh   | wire infill 50 x 50 mm, Ø 4 mm  |
| Shelves  | optionally available  |
| Wheels   | 2 swivel and 2 swivel castors with brakes, Ø 125 mm, elastic (grey), ball bearing |
| Surface  | blue galvanized   |



## BERLIN 3.0

A light and versatile laundry container, that's our 3-sided Berlin. The height of 1800 mm is achieved with a Ø 20 mm round tube supported in the structure. This offers stability and plenty of space for the most diverse possible applications. The Berlin is assembled quickly and easy to use. This system is rounded off with non-marking elastic castors. You are also looking for suitable accessories, please contact us. Together we will find the right solution for your company.

**Features:**

- 3-sided laundry container
- 2 swivel and 2 fixed castors, Ø 100 mm, elastic (grey), ball bearing
- up to 400 kg load capacity
- easy handling
- usable height: 1650 mm
- color: blue galvanized



More accessories and castor sets available.

|  | Berlin 3.0<br>Steel Bottom   |
|--|--|
| Article number   | S3600800CC051  |
| Composition  | 3-sided  |
| Overall dimensions, W x D x H mm<br>Total height with Ø 100 mm castors | 600 x 800 x 1800   |
| Internal dimensions (W x D x H mm)                                     | 560 x 770 x 1650   |
| Payload  | 400 kg   |
| Weight   | 25 kg  |
| Mesh   | round bar: 4 x vertical (Ø 6 mm),<br>3 x horizontal (Ø 6 mm)         |
| Shelves  | not available  |
| Wheels   | 2 swivel and 2 fixed castors, Ø 100 mm, elastic (grey), ball bearing |
| Surface  | blue galvanized  |



## DRESDEN 3.3

Our Dresden laundry container can easily be equipped with six intermediate shelves. The three shelves included in the scope of delivery have an upstand for load securing. Here you can decide whether you want the version with or without a 20° angle of the horizontal flat iron. The four swivel castors - two of them with brakes - allows good handling even with a full load.

**Features:**

- 3-sided laundry container
- 2 swivel and 2 swivel castors with brakes, Ø 108 mm, polypropylene, ball bearing
- 3 intermediate shelves with upstand (up to 6 possible)
- with or without 20° angle
- recyclable plastic bottom



More accessories and castor sets available.

|  | Dresden 3.3 (20°)<br>Plastic Bottom  | Dresden 3.3<br>Plastic Bottom        |
|--|--|--------------------------------------|
| Article number   | KRR3A50101600C104  | KRR3A50101600C204                    |
| Composition  | 3-sided  |                                      |
| Overall dimensions, W x D x H mm<br>Total height with Ø 108 mm castors | 815 x 724 x 1800   |                                      |
| Internal dimensions (W x D x H mm)                                     | 750 x 680 x 1600   |                                      |
| Payload  | 500 kg   |                                      |
| Weight   | 52,2 kg  |                                      |
| Mesh   | flat steel bar: 6 x vertical, 6 x horizontal (15 x 3 mm)                         |                                      |
| Shelves  | 3 shelves included<br>(with 20° tilt)  | 3 shelves included<br>(without tilt) |
| Wheels   | 2 swivel and 2 swivel castors with brakes, Ø 108 mm, polypropylene, ball bearing |                                      |
| Surface  | blue galvanized  |                                      |





## FRANKFURT L

Our Frankfurt L laundry container is with 2- to 4-sides available and has a height of 1660 mm. The swivelmounted and foldable door allows a comfortable handling and makes work easier (4-sided). In addition, the Frankfurt L container scores with an easy and quick assembly / disassembly. The matching plastic bottom is made of high quality HDPE material and is 100% recyclable. Additionally a individual color (RAL) and/ or embossing is possible.

**Features:**

- 2-, 3-, or 4-sided laundry container
- 2 swivel and 2 fixed castors, Ø 108 mm, polypropylene, ball bearing
- swivel-mounted & foldable door (4-sided)
- recyclable plastic bottom



Two different door types available.

|  | Frankfurt L 2.0<br>Plastic Bottom                                   | Frankfurt L 3.0<br>Plastic Bottom | Frankfurt L 4.0<br>Plastic Bottom | Frankfurt L 4.0.1<br>Plastic Bottom |
|--|---|-----------------------------------|-----------------------------------|-------------------------------------|
| Article number   | KB2A50101460<br>CS03101   | KB3A50101460<br>CS03101           | KB4A50101460<br>CS03101           | KB4A50101460<br>CS03301             |
| Composition  | 2-sided   | 3-sided                           | 4-sided                           |                                     |
| Overall dimensions, W x D x H mm<br>Total height with Ø 108 mm castors | 724 x 815 x 1660  |                                   |                                   |                                     |
| Internal dimensions (W x D x H mm)                                     | 660 x 800 x 1450  | 660 x 775 x 1450                  | 660 x 750 x 1450                  |                                     |
| Payload  | 500 kg  |                                   |                                   |                                     |
| Weight   | 22 kg   | 28 kg                             | 37 kg                             | 37 kg                               |
| Mesh   | flat steel bar: 4 x vertical, 4 x horizontal (12 x 3 mm)            |                                   |                                   |                                     |
| Shelves  | optionally available  |                                   |                                   |                                     |
| Wheels   | 2 swivel and 2 fixed castors, Ø 108 mm, polypropylene, ball bearing |                                   |                                   |                                     |
| Surface  | blue galvanized   |                                   |                                   |                                     |



## FRANKFURT XL

The higher version, the Frankfurt XL, has a height of 1850 mm and comes with the same advantages as its L-version. Also you can choose between a 1- or 2-part front wall. The standard base plate is available in dark blue, but green, grey or red are possible as well. At the same time, the base plate for the Frankfurt laundry container is also available as closed/ smoother bottom version. Please contact us for further variations.

**Features:**

- same as Frankfurt L (page 28)
- 2 half front walls, individually swivelling & foldable
- maximum usable height: 1640 mm



2-part front wall also available as foldable version.

|  | Frankfurt XL 2.0<br>Plastic Bottom                                  | Frankfurt XL 3.0<br>Plastic Bottom | Frankfurt XL 4.0.1<br>Plastic Bottom | Frankfurt XL 4.0.2<br>Plastic Bottom |
|--|---|------------------------------------|--------------------------------------|--------------------------------------|
| Article number   | KB2A50101650<br>CS04101   | KB3A50101650<br>CS04101            | KB4A50101650<br>CS04301              | KB4A50101650<br>CS04201              |
| Composition  | 2-sided   | 3-sided                            | 4-sided                              |                                      |
| Overall dimensions, W x D x H mm<br>Total height with Ø 108 mm castors | 724 x 815 x 1850  |                                    |                                      |                                      |
| Internal dimensions (W x D x H mm)                                     | 660 x 800 x 1640  | 660 x 775 x 1640                   | 660 x 750 x 1640                     |                                      |
| Payload  | 500 kg  |                                    |                                      |                                      |
| Weight   | 22,5 kg   | 28,4 kg                            | 37 kg                                | 37,9 kg                              |
| Mesh   | flat steel bar: 4 x vertical, 5 x horizontal (12 x 3 mm)            |                                    |                                      |                                      |
| Shelves  | optionally available  |                                    |                                      |                                      |
| Wheels   | 2 swivel and 2 fixed castors, Ø 108 mm, polypropylene, ball bearing |                                    |                                      |                                      |
| Surface  | blue galvanized   |                                    |                                      |                                      |



## DUISBURG I

with the classic **Duisburg I** spring bottom trolley, made of anodized aluminium, you can do your laundry transport optimally. The low weight and the four swivel castors support flexibility when working. The immediate reaction of the spring bottom to a change in weight additionally underlines back-friendly work.

**Features:**

- constant loading and unloading height
- anodizing protects against abrasion and corrosion
- stable edge profiles on the top and bottom of the trolley
- 4 swivel castors, Ø 125 mm

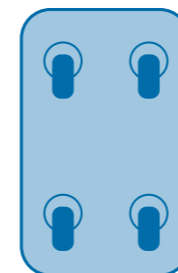

Optimal price-performance ratio.

|  | Duisburg I S D  | Duisburg I M D    |
|--|---|-------------------|
| Article number   | FBWAECD1408180D00   | FBWAECD1408350D00 |
| Overall dimensions, W x D x H mm<br>Total height with Ø 125 mm castors | 845 x 540 x 760   | 1105 x 680 x 855  |
| Internal dimensions (W x D x H mm)                                     | 740 x 510 x 485   | 1000 x 650 x 580  |
| Payload  | 100 kg  |                   |
| Weight   | 26 kg   | 33 kg             |
| Volume   | 180 liter   | 380 liter         |
| Spring force   | 25 kg   |                   |
| Wheels   | 4 swivel castors, Ø 125 mm, TPR, ball bearing, optional: 2 with total brake |                   |
| Configuration of wheels  | 2 + 2   |                   |



## DUISBURG II



The **Duisburg II** takes over the advantages of the classic Duisburg I and is expanded through further flexibility. The spring force can be adjusted according to your own needs. The smooth side walls reduce the friction of the load and thus favor the immediate reaction of the spring bottom noticeable. Further options such as changing the castors of the chassis are possible additionally.

**Features:**

- anodized aluminium
- no tilting with one-sided loading
- elastic PVC bumper on the upper edge of the trolley
- stable chassis carrier made of galvanized steel
- 3 different castors arrangements, TPR, ball bearing

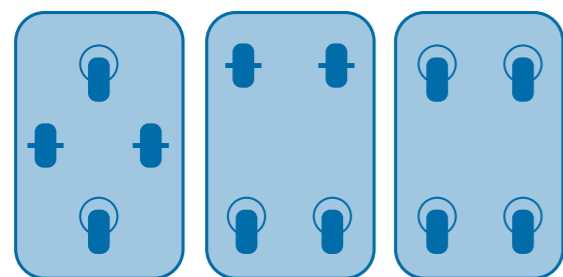

Swivel castors with or without brakes possible.

## DUISBURG III



The **Duisburg III** is the larger spring bottom trolley in this series with a capacity of 615 liters and an external dimension of 1515 x 740 x 905 mm. While the Duisburg III L B is available non-anodized, the Duisburg III L A comes along anodized. The thermoplastic rubber treads allow you to move the trolley around without any trace.

**Features:**

- non-anodized & anodized aluminium
- easy adjustment of the spring force
- chassis modification possible
- 2 different castors arrangements

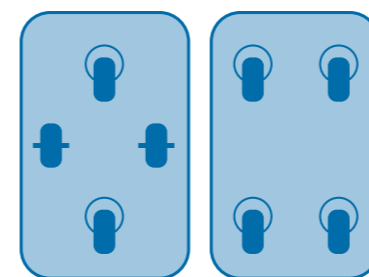

Duisburg III L B is not anodized.

Items inside the products are not included.

|  | Duisburg II M A  | Duisburg II M B   | Duisburg II M D                               |
|--|--|---|---|
| Article number   | FBWAEVD1408350A00                                      | FBWAEVD1408350B00   | FBWAEVD1408350D00                             |
| Overall dimensions, W x D x H mm<br>Total height with Ø 125 mm castors | 1115 x 690 x 855                                       |   |   |
| Internal dimensions (W x D x H mm)                                     | 1000 x 650 x 580                                       |   |   |
| Payload  | 130 kg   |   |   |
| Weight   | 44 kg  |   | 42 kg   |
| Volume   | 380 liter  |   |   |
| Spring force   | 50 kg  | 70 kg   | 25 kg   |
| Wheels   | 2 swivel and 2 fixed castors, Ø 125 mm, diamond-shaped | 2 swivel castors with total brake and 2 fixed castors, Ø 125 mm | 4 swivel castors, Ø 125 mm, TPR, ball bearing |
| Configuration of wheels  | 1 + 2 + 1  | 2 + 2   | 2 + 2   |

|  | Duisburg III L A  | Duisburg III L B   |
|--|---|--|
| Article number   | FBWAEVD5408580A00   | FBWAVD5408580B00   |
| Overall dimensions, W x D x H mm<br>Total height with Ø 125 mm castors | 1515 x 740 x 905  | 1515 x 740 x 835   |
| Internal dimensions (W x D x H mm)                                     | 1400 x 700 x 620  |  |
| Payload  | 100 kg  |  |
| Weight   | 51 kg   | 55 kg  |
| Volume   | 615 liter   |  |
| Spring force   | 50 kg   | 70 kg  |
| Wheels   | 2 swivel and 2 fixed castors, Ø 125 mm, TPR, ball bearing, diamond-shaped | 2 swivel castors with total brake and 2 fixed castors, Ø 125 mm, TPR, ball bearing |
| Configuration of wheels  | 1 + 2 + 1   | 2 + 2  |



\*Lid optional

## ROSTOCK

with our versatile aluminium transport trolley **Rostock** you use the maximum transport capacity with the least possible own weight. The Rostock simplifies the transport of your goods in the company perfectly and is available in four different sizes. In addition, a matching lid or another castor arrangement can be selected.

**Features:**

- generally usable
- very solid with low weight
- scratch-resistant surface
- available in 4 volume sizes
- different castor arrangements possible, TPR, ball bearing

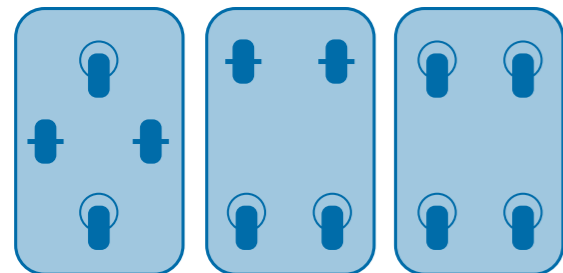

Also available with lid.



\*Lid optional

## CHEMNITZ

The **Chemnitz** is a very stable transport trolley made of aluminium, which offers one longitudinal wall that can be folded down halfway. While the walls are stiffened by surrounding beads, the upper and lower edge of the trolley will be reinforced by all-round aluminium profiles. Through the combination of stability and flexibility your work will be made easier in general.

**Features:**

- one longitudinal wall can be folded down halfway
- reinforced walls with trapezoidal beads
- 2 volume sizes available
- castor arrangement: 2 + 2

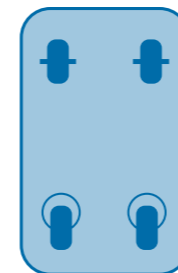

Cylinder lock optionally available.

Items inside the products are not included.

|  | Rostock S B   | Rostock M B   | Rostock L B      | Rostock XL B     |
|--|---|---|------------------|------------------|
| Article number   | TWAD3008330B00  | TWAD3008415B00  | TWAD3008570B00   | TWAD3008656B00   |
| Overall dimensions, W x D x H mm<br>(Total height with Ø 100/125 mm castors) | 990 x 580 x 770   | 1030 x 670 x 835  | 1280 x 680 x 870 | 1280 x 730 x 935 |
| Internal dimensions (W x D x H mm)   | 960 x 550 x 610   | 1000 x 640 x 650  | 1250 x 650 x 685 | 1250 x 700 x 750 |
| Payload  | 200 kg  |   | 250 kg           |                  |
| Weight   | 18,5 kg   | 22 kg   | 25 kg            | 26,5 kg          |
| Volume   | 322 liter   | 415 liter   | 560 liter        | 656 liter        |
| Lid  | optionally available  |   |                  |                  |
| Wheels   | 2 swivel castors with total brake and 2 fixed castors, Ø 100 mm | 2 swivel castors with total brake and 2 fixed castors, Ø 125 mm |                  |                  |
| Configuration of wheels  | 2 + 2   |   |                  |                  |

|  | Chemnitz M   | Chemnitz M (with Lid) | Chemnitz L   | Chemnitz L (with Lid) |
|--|--|-----------------------|--|-----------------------|
| Article number   | TWAD3508360B00   | TWAD3508360B01        | TWAD35081050B00  | TWAD35081050B01       |
| Overall dimensions, W x D x H mm<br>(Total height with Ø 125/160 mm castors) | 930 x 530 x 985  | 960 x 555 x 990       | 1280 x 730 x 1430  | 1310 x 755 x 1435     |
| Internal dimensions (W x D x H mm)   | 900 x 500 x 800  |                       | 1250 x 700 x 1200  |                       |
| Payload  | 250 kg   |                       | 300 kg   |                       |
| Weight   | 22,5 kg  | 25,5 kg               | 40 kg  | 46 kg                 |
| Volume   | 355 liter  |                       | 1050 liter   |                       |
| Lid  | optionally available   | enthalten             | optionally available   | enthalten             |
| Wheels   | 2 swivel castors with total brake and 2 fixed castors, Ø 125 mm, TPR, ball bearing |                       | 2 swivel castors with total brake and 2 fixed castors, Ø 160 mm, TPR, ball bearing |                       |
| Configuration of wheels  | 2 + 2  |                       |  |                       |





## LUBECK

This extremely stable aluminium transport trolley is ideal for easy loading and unloading due to its longitudinal wall, that can be lowered down to the half. Especially with large volume cargo, such as laundry and rubbish bags. At the same time, Lubeck helps optimal in tight space conditions. The optional hinged lid is secured with two lever latches.

### Features:

- one longitudinal wall can be lowered down to the half
- long wall and front are without beads
- 2 volume sizes available
- castor arrangement: 2 + 2

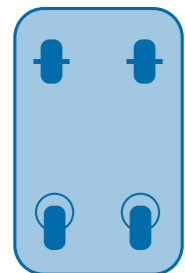

Push handle optionally available.

## AACHEN

The Aachen comes with a 250 mm high wall cutout and is therefore ideal for easy loading and unloading, especially with larger goods. The anodized push handles on both side walls simplify handling and movements in your company. Contact us for more options.

### Features:

- long wall cut-out of 1130 x 250 mm
- push handles are anodized
- ergonomic work through simple loading and unloading
- castor arrangement: 2 + 2

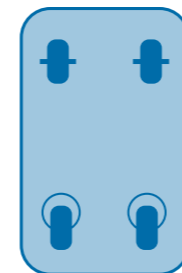

Push handles enable easy handling.

Items inside the products are not included.

|   | Lubeck M   | Lubeck M (with Lid) | Lubeck L             | Lubeck L (with Lid) |
|---|--|---------------------|----------------------|---------------------|
| Article number  | TWAD3708360B00   | TWAD3708360B01      | TWAD3708650B00       | TWAD3708650B01      |
| Overall dimensions, W x D x H mm (Total height with Ø 125 mm castors) | 930 x 525 x 985  | 960 x 550 x 990     | 1280 x 675 x 985     | 1310 x 700 x 990    |
| Internal dimensions (W x D x H mm)                                    | 900 x 495 x 800  |                     | 1250 x 645 x 800     |                     |
| Payload   | 250 kg   |                     |                      |                     |
| Weight  | 24 kg  | 27 kg               | 31 kg                | 37 kg               |
| Volume  | 355 liter  |                     | 650 liter            |                     |
| Lid   | optionally available   | included            | optionally available | included            |
| Wheels  | 2 swivel castors with total brake and 2 fixed castors, Ø 125 mm, TPR, ball bearing |                     |                      |                     |
| Configuration of wheels   | 2 + 2  |                     |                      |                     |

|   | Aachen   |
|---|--|
| Article number  | TWAD3808945B00   |
| Overall dimensions, W x D x H mm (Total height with Ø 200 mm castors) | 1680 x 930 x 970   |
| Internal dimensions (W x D x H mm)                                    | 1500 x 900 x 700   |
| Payload   | 300 kg   |
| Weight  | 44 kg  |
| Volume  | 945 liter  |
| Lid   | not available  |
| Wheels  | 2 swivel castors with total brake and 2 fixed castors, Ø 200 mm, TPR, ball bearing |
| Configuration of wheels   | 2 + 2  |

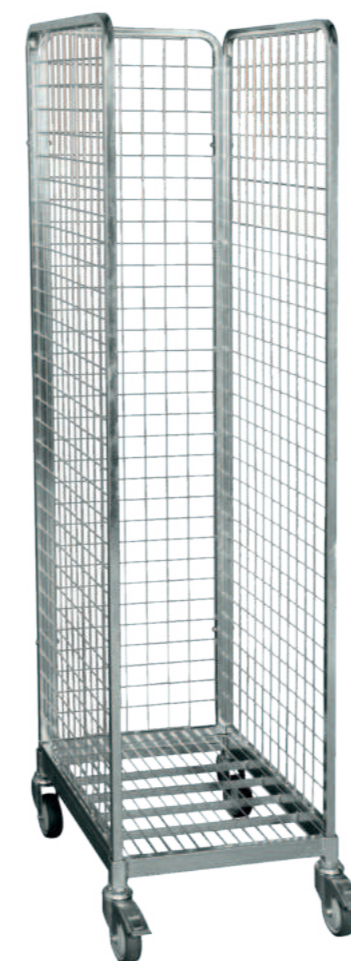
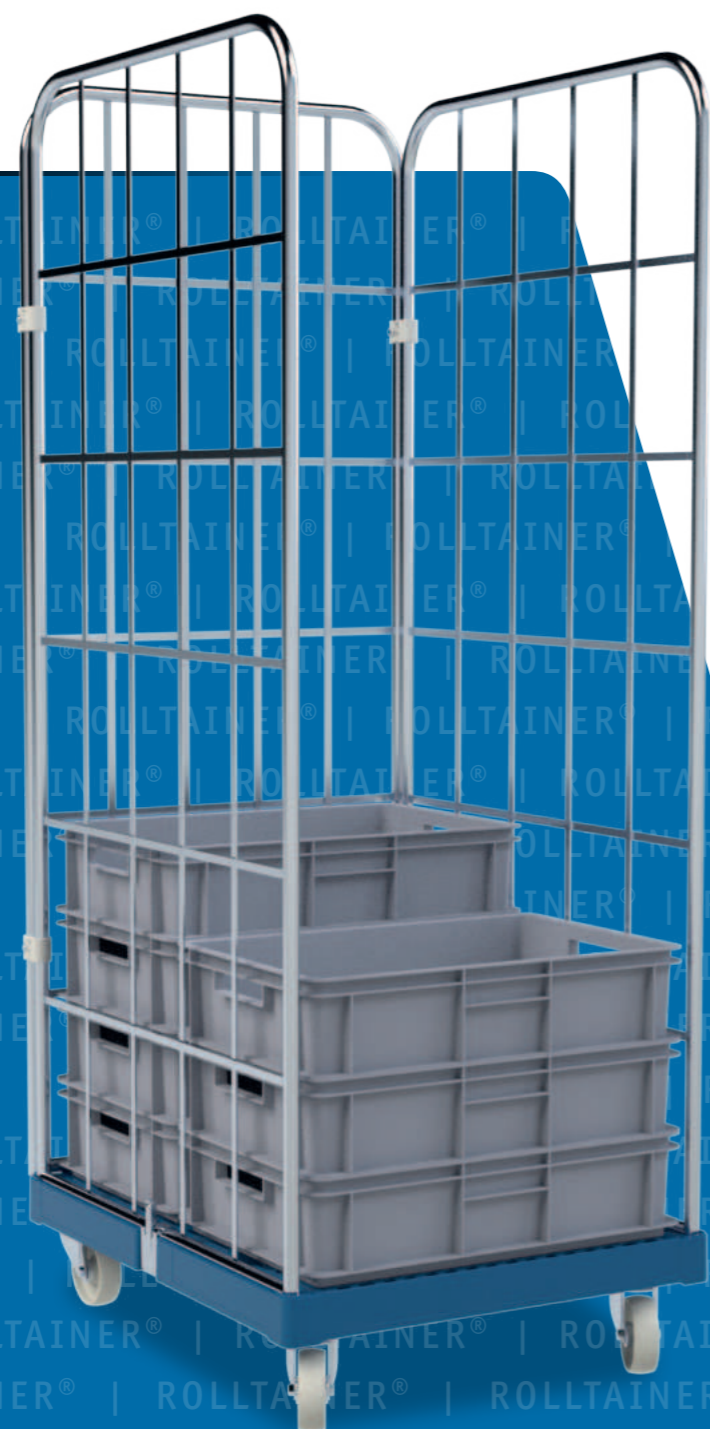

## LEIPZIG

Our rolltainer® Leipzig was specially designed for the transport of standard boxes 600 x 400 mm. Thanks to the close mesh the intermediate shelves can be used flexible. Therefore the container offers a high flexibility. The intermediate shelves are available with and without upstand and ensure the first load securing.

### Features:

- 3-, 4- or 5-sided rolltainer®
- 2 swivel castors and 2 swivel castors with brakes, Ø 100 mm, ball bearing, TPR tread
- up to 300 kg load capacity
- swivel-mounted door (4-5-sided)
- optional intermediate shelves with / without upstand individually applicable
- stable construction



Available from 3 to 5 sides, intermediate shelves with/without upstand.

|  | Leipzig 3.0<br>Steel Bottom   | Leipzig 4.0<br>Steel Bottom | Leipzig 5.0<br>Steel Bottom |
|--|---|-----------------------------|-----------------------------|
| Article number   | S3460640FC057   | S4460640FC057               | S5460640FC057               |
| Composition  | 3-sided   | 4-sided                     | 5-sided                     |
| Overall dimensions, W x D x H mm<br>Total height with Ø 100 mm castors | 460 x 640 x 1832  | 460 x 640 x 1855            | 460 x 640 x 1855            |
| Internal dimensions (W x D x H mm)                                     | 420 x 620 x 1645  |                             | 420 x 620 x 1645            |
| Payload  | 300 kg  |                             |                             |
| Weight   | 34,9 kg   | 36 kg                       | 39,75 kg                    |
| Mesh   | wire infill 50 x 50 mm, Ø 4 mm  |                             |                             |
| Shelves  | optionally available, also with / without upstand   |                             |                             |
| Wheels   | 2 swivel and 2 swivel castors with total brake, Ø 100 mm, rim of polypropylene, ball bearing, TPR tread |                             |                             |
| Surface  | blue galvanized   |                             |                             |



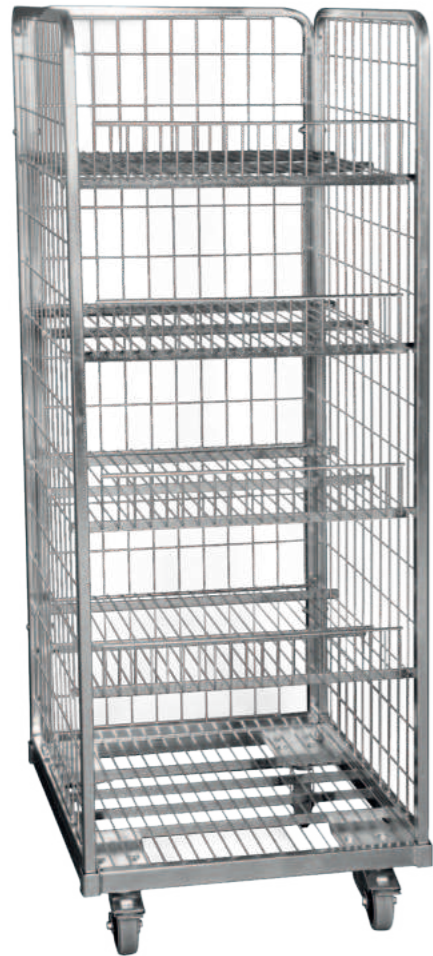

## MUNICH

Our Munich rolltainer® is available in two versions, 2-sided with stability bar or 3-sided with back wall. Smooth running features, intermediate shelves with an upstand of 20 mm or 100 mm for the first load securing and the stable design distinguish the rolltainer®. Fit the rolltainer® to your needs, we offer you the right accessories.

### Features:

- 2- or 3-sided rolltainer®
- 2 swivel castors and 2 swivel castors with brakes, Ø 100 mm elastic (grey), ball bearing
- intermediate shelves with 100 mm upstand (20 mm also possible)
- steel bottom 600 x 600 mm



Intermediate shelves available with 20 or 100 mm upstand.

|  | Munich 2.4<br>Steel Bottom   | Munich 3.4<br>Steel Bottom |
|--|--|----------------------------|
| Article number   | S2600600FC4Z158  | S3600600FC4Z158            |
| Composition  | 2-sided  | 3-sided                    |
| Overall dimensions, W x D x H mm<br>Total height with Ø 100 mm castors | 600 x 600 x 1670   | 600 x 600 x 1650           |
| Internal dimensions (W x D x H mm)                                     | 560 x 600 x 1465   | 560 x 580 x 1465           |
| Payload  | 500 kg   |                            |
| Weight   | 38 kg  | 48 kg                      |
| Mesh   | wire infill 50 x 100 mm, Ø 4 mm  |                            |
| Shelves  | 4 shelves with 100 mm upstand included   |                            |
| Wheels   | 2 swivel and 2 swivel castors with total brake, Ø 100 mm, elastic (grey), ball bearing |                            |
| Surface  | blue galvanized  |                            |



## COLOGNE 3.0

Our Cologne rolltainer® was specially designed for the transport of plastic boxes in the dimensions 600 x 400 and 600 x 800 mm and is available in two different heights. With the help of our optionally available intermediate shelves you can add additional levels and organize your goods optimally. We offer you other accessories, such as textile straps for load securing.

### Features:

- 3-sided rolltainer®
- 2 swivel and 2 fixed castors, Ø 108 mm, polypropylene
- recyclable plastic bottom made of high quality HDPE material in 682 x 815 mm
- up to 4 intermediate shelves possible (Cologne L 3.0)
- up to 5 intermediate shelves possible (Cologne XL 3.0)
- color: blue galvanized



Optional intermediate shelves and more accessories available.

Items inside the products are not included.

|  | Cologne L 3.0<br>Plastic Bottom                                     | Cologne XL 3.0<br>Plastic Bottom |
|--|---|----------------------------------|
| Article number   | KB3B50101460CS03101   | KB3B50101650CS04101              |
| Composition  | 3-sided   |                                  |
| Overall dimensions, W x D x H mm<br>Total height with Ø 108 mm castors | 682 x 815 x 1660  | 682 x 815 x 1850                 |
| Internal dimensions (W x D x H mm)                                     | 640 x 800 x 1450  | 640 x 775 x 1640                 |
| Payload  | 500 kg  |                                  |
| Weight   | 28 kg   | 29,5 kg                          |
| Mesh   | flat steel bar 12 x 3 mm  |                                  |
| Shelves  | optionally available  |                                  |
| Wheels   | 2 swivel and 2 fixed castors, Ø 108 mm, polypropylene, ball bearing |                                  |
| Surface  | blue galvanized   |                                  |



## KIEL

Our anti-theft container **Kiel** is designed for the safe transport of Euronorm boxes. The tight wire infill and the lockable door (lock not included) offer direct protection against unauthorized access and secure your goods reliably. At the same time you can add intermediate shelves every 50 mm. With additional accessories or another castor set you can customize the rolltainer® to your needs.

### Features:

- 3-, 4- or 5-sided wire mesh container
- 2 swivel and 2 fixed castors, Ø 108 mm, polypropylene
- swivel-mounted and lockable door (4- and 5-sided)
- intermediate shelves adjustable every 50 mm
- recyclable plastic bottom in 682 x 820 mm
- especially for euronorm boxes
- color: blue galvanized



Optional intermediate shelves and more accessories available.

Items inside the products are not included.

|  | Kiel 3.0<br>Plastic Bottom  | Kiel 4.0<br>Plastic Bottom | Kiel 5.0<br>Plastic Bottom |
|--|---|----------------------------|----------------------------|
| Article number   | KAD3B50101600COZ101   | KAD4B50101600COZ101        | KAD5B50101600COZ101        |
| Composition  | 3-sided   | 4-sided                    | 5-sided                    |
| Overall dimensions, W x D x H mm<br>Total height with Ø 108 mm castors | 682 x 870 x 1800  |                            |                            |
| Internal dimensions (W x D x H mm)                                     | 620 x 825 x 1610  | 620 x 825 x 1610           | 620 x 800 x 1585           |
| Payload  | 500 kg  |                            |                            |
| Weight   | 34 kg   | 43 kg                      | 46 kg                      |
| Mesh   | wire infill 50 x 50 mm, Ø 4 mm                                      |                            |                            |
| Shelves  | optionally available  |                            |                            |
| Wheels   | 2 swivel and 2 fixed castors, Ø 108 mm, polypropylene, ball bearing |                            |                            |
| Surface  | blue galvanized   |                            |                            |

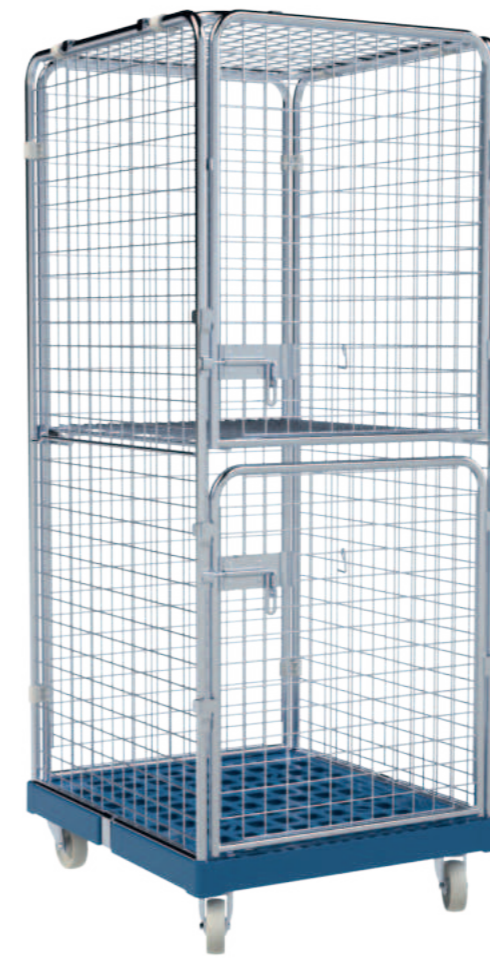

## HAMBURG

We offer our anti-theft container **Hamburg** in different versions. With the 50 x 50 mm infill you do not only protect your goods from external access, you also can position the additional intermediate shelves in a very variable way. The Hamburg is available with a 1- and 2-part front wall that can be locked (lock not included). You also can get a 3 or 4-sided container.

### Features:

- 3-, 4- or 5-sided rolltainer®
- 2 swivel and 2 fixed castors, Ø 108 mm, polypropylene
- swivel-mounted and lockable door (4- and 5-sided)
- recyclable plastic bottom in 724 x 815 mm
- color: blue galvanized



Hamburg available with wing- and foldable door.

|  | Hamburg 3.0<br>Plastic Bottom                                       | Hamburg 4.0<br>Plastic Bottom | Hamburg 5.0<br>Plastic Bottom | Hamburg 5.1.2<br>Plastic Bottom |
|--|---|-------------------------------|-------------------------------|---------------------------------|
| Article number   | KAD3A50101600<br>COZ101   | KAD4A50101600<br>COZ101       | KAD5A50101600<br>COZ101       | KAD5A50101600<br>C1Z201         |
| Composition  | 3-sided   | 4-sided                       | 5-sided                       |                                 |
| Overall dimensions, W x D x H mm<br>Total height with Ø 108 mm castors | 724 x 815 x 1800  |                               |                               |                                 |
| Internal dimensions (W x D x H mm)                                     | 660 x 775 x 1600  | 660 x 750 x 1600              |                               |                                 |
| Payload  | 500 kg  |                               |                               |                                 |
| Weight   | 37,5 kg   | 43 kg                         | 48 kg                         | 52 kg                           |
| Mesh   | wire infill 50 x 50 mm, Ø 4 mm                                      |                               |                               |                                 |
| Shelves  | optionally available  |                               |                               | 1 shelf included                |
| Wheels   | 2 swivel and 2 fixed castors, Ø 108 mm, polypropylene, ball bearing |                               |                               |                                 |
| Surface  | blue galvanized   |                               |                               |                                 |



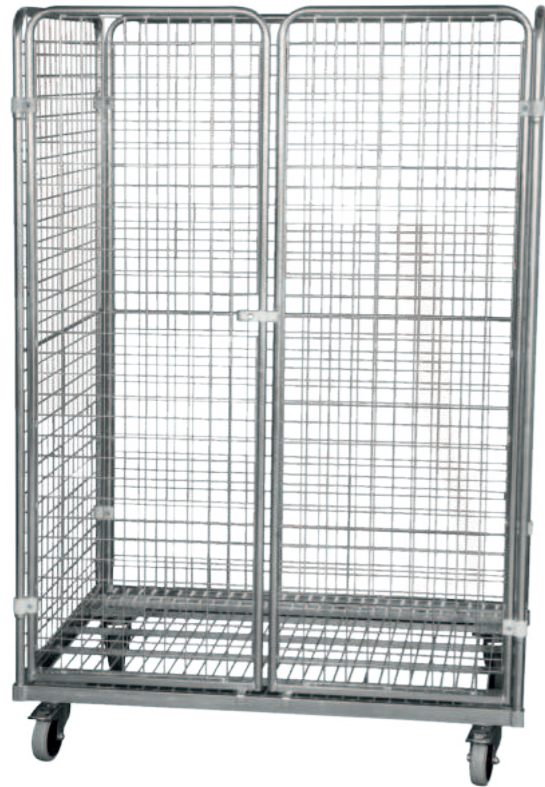

## MUNSTER

Our **Munster** rolltainer® offers you a lot of space to store your goods safely. The Munster is available as a 2- to 5-sided rolltainer®. The optionally available intermediate shelves are available with or without upstand and can be positioned at an angle. This container is ideal to transport your goods and to present to your customers at the same time. Further adjustments are possible on request.

**Features:**

- 2-, 3-, 4- or 5-sided rolltainer®
- 2 swivel castors and 2 swivel castors with brakes, Ø 125 mm, elastic (grey), ball bearing
- swivel-mounted wing-door
- steel bottom 1200 x 800 mm



Further adjustments are possible on request, please contact us!

|  | Munster 2.0<br>Steel Bottom  | Munster 3.0<br>Steel Bottom | Munster 4.0<br>Steel Bottom | Munster 5.0<br>Steel Bottom |
|--|--|-----------------------------|-----------------------------|-----------------------------|
| Article number   | S28001200FC053   | S38001200FC053              | S48001200FC153              | S58001200FC053              |
| Composition  | 2-sided  | 3-sided                     | 4-sided                     | 5-sided                     |
| Overall dimensions, W x D x H mm<br>Total height with Ø 125 mm castors | 1200 x 800 x 1820  |                             |                             |                             |
| Internal dimensions (W x D x H mm)                                     | 1150 x 790 x 1605  | 1150 x 775 x 1605           | 1150 x 750 x 1605           | 1150 x 750 x 1575           |
| Payload  | 600 kg   |                             |                             |                             |
| Weight   | 43,3 kg  | 50,8 kg                     | 66,3 kg                     | 73 kg                       |
| Mesh   | wire infill 50 x 50 mm, Ø 4 mm   |                             |                             |                             |
| Shelves  | optionally available   |                             |                             |                             |
| Wheels   | 2 swivel and 2 swivel castors with total brake, Ø 125 mm, elastic (grey), ball bearing |                             |                             |                             |
| Surface  | blue galvanized  |                             |                             |                             |



## MAINZ

Our **Mainz** rolltainer® is one of our largest rolltainer® and is great for the transport of your goods on euro pallets. It offers a possible payload of up to 800 kg. Optionally you can also equip the rolltainer® with intermediate shelves to divide it into levels. The rolltainer® is available in 3-, 4- or 5-sided versions.

**Features:**

- 3-, 4- or 5-sided rolltainer®
- 2 swivel castors and 2 swivel castors with brakes, Ø 125 mm, elastic (grey), ball bearing
- swivel-mounted wing-door (4- and 5-sided)
- steel bottom 1350 x 950 mm



Suitable for euro pallets!

Items inside the products are not included.

|  | Mainz 3.0<br>Steel Bottom  | Mainz 4.0<br>Steel Bottom | Mainz 5.0<br>Steel Bottom |
|--|--|---------------------------|---------------------------|
| Article number   | S39501350FC059   | S49501350FC159            | S59501350FC059            |
| Composition  | 3-sided  | 4-sided                   | 5-sided                   |
| Overall dimensions, W x D x H mm<br>Total height with Ø 125 mm castors | 1350 x 950 x 1820  |                           |                           |
| Internal dimensions (W x D x H mm)                                     | 1298 x 920 x 1605  | 1298 x 887 x 1605         |                           |
| Payload  | 800 kg   |                           |                           |
| Weight   | 68,6 kg  | 85 kg                     | 94,2 kg                   |
| Mesh   | wire infill 50 x 50 mm, Ø 4 mm   |                           |                           |
| Shelves  | optionally available   |                           |                           |
| Wheels   | 2 swivel and 2 swivel castors with total brake, Ø 125 mm, elastic (grey), ball bearing |                           |                           |
| Surface  | blue galvanized  |                           |                           |



## ESSEN

Our nestainer® Essen is available in three versions from 2- to 4-sides. The bottom has an innovative spring technology and can be folded to the side. The rolltainer® is nestable and therefore guarantees an optimal transport of empties. This does not only save important storage space but also allows the transport of a larger amount of container (when empty).

### Features:

- 2-, 3-, or 4-sided nestainer®
- 2 swivel and 2 fixed castors, Ø 108 mm, polyamide, ball bearing
- spring technology in the bottom
- steel bottom 700 x 800 mm
- color: blue galvanized



Nestainer® save storage and transport costs!

|  | Essen 2.0<br>Steel Bottom                                       | Essen 3.0<br>Steel Bottom | Essen 4.0<br>Steel Bottom |
|--|---|---------------------------|---------------------------|
| Article number   | N2700800CCOZ019   | N3700800CCOZ019           | N4700800CCOZ019           |
| Composition  | 2-sided   | 3-sided                   | 4-sided                   |
| Overall dimensions, W x D x H mm<br>Total height with Ø 108 mm castors | 700 x 800 x 1665  |                           |                           |
| Internal dimensions (W x D x H mm)                                     | 655 x 800 x 1465  | 655 x 770 x 1465          | 655 x 740 x 1465          |
| Payload  | 500 kg  |                           |                           |
| Weight   | 29,9 kg   | 36,1 kg                   | 42,3 kg                   |
| Mesh   | flat steel bar 12 x 3 mm  |                           |                           |
| Shelves  | optionally available  |                           |                           |
| Wheels   | 2 swivel and 2 fixed castors, Ø 108 mm, polyamide, ball bearing |                           |                           |
| Surface  | blue galvanized   |                           |                           |





## JENA

Our nestainer® Jena offers you plenty of space for your goods and a space-saving return in empty state. The plastic bottom of the container is foldable to the back using a spring mechanism. The smooth running elastic castor set offers increased comfort and a locking function to prevent unintentional movement of the container.

### Features:

- 3- or 4-sided nestainer®
- 2 swivel castors with brakes and 2 fixed castors, Ø 125 mm, tread with elastic (grey), ball bearing
- swivel-mounted door (4-sided)
- 1 foldable intermediate shelf (also available without )
- recyclable plastic bottom



Also available with a steel bottom.

|  | Jena 3.1<br>Plastic Bottom   | Jena 4.1<br>Plastic Bottom |
|--|--|----------------------------|
| Article number   | N3A1450KC1Z246   | N4A1450KC1Z246             |
| Composition  | 3-sided  | 4-sided                    |
| Overall dimensions, W x D x H mm<br>Total height with Ø 125 mm castors | 729 x 818 x 1660   |                            |
| Internal dimensions (W x D x H mm)                                     | 673 x 794 x 1428   | 673 x 769 x 1428           |
| Payload  | 500 kg   |                            |
| Weight   | 47,2 kg  | 53,8 kg                    |
| Mesh   | wire sticks Ø 6 mm   |                            |
| Shelves  | 1 shelf included   |                            |
| Wheels   | 2 swivel castors with total brake and 2 fixed castors, Ø 125 mm, rim made of polyamide, tread made of elastic (grey), ball bearing |                            |
| Surface  | blue galvanized  |                            |



## HANOVER

Our nestainer® Hanover is available to you as a 3- or 4-sided container. The intermediate plastic shelf which is equipped in the basic version divides the container into two levels and can be folded down, so you can organize your goods optimally. Alternatively you can add another intermediate shelf each in the lower and upper third. The smooth-running set of castors increase the comfort.

### Features:

- 3- or 4-sided nestainer®
- 2 swivel castors with brakes and 2 fixed castors, Ø 125 mm, tread with elastic (grey), ball bearing
- up to 2 foldable intermediate shelves
- recyclable plastic bottom



Nestainer® with smooth-running brand castors.

|  | Hannover 3.1<br>Plastic Bottom   | Hannover 3.2<br>Plastic Bottom | Hannover 4.1<br>Plastic Bottom | Hannover 4.2<br>Plastic Bottom |
|--|--|--------------------------------|--------------------------------|--------------------------------|
| Article number   | N3A1550KC1Z546   | N3A1550KC2Z646                 | N4A1550KC1Z546                 | N4A1550KC2Z646                 |
| Composition  | 3-sided  |                                | 4-sided                        |                                |
| Overall dimensions, W x D x H mm<br>Total height with Ø 125 mm castors | 729 x 818 x 1770   |                                |                                |                                |
| Internal dimensions (W x D x H mm)                                     | 729 x 818 x 1770   |                                | 673 x 769 x 1538               |                                |
| Payload  | 500 kg   |                                |                                |                                |
| Weight   | 53,4 kg  | 57,1 kg                        | 59,6 kg                        | 64 kg                          |
| Mesh   | wire sticks Ø 6 mm   |                                |                                |                                |
| Shelves  | 1 shelf included   | 2 shelves included             | 1 shelf included               | 2 shelves included             |
| Wheels   | 2 swivel castors with total brake and 2 fixed castors, Ø 125 mm, rim made of polyamide, tread made of elastic (grey), ball bearing |                                |                                |                                |
| Surface  | blue galvanized  |                                |                                |                                |



## FURTH

Our anti-theft nestainer® **Furth** does not only offer you the possibility of space-saving return transport, but also a direct pretection against unauthorized access to your goods. The door of the nestable container can be locked (lock not included). The top, the intermediate shelf and the bottom are optionally available in plastic or steel.

### Features:

- 5-sided nestainer®
- 2 swivel castors with brakes and 2 fixed castors, Ø 125 mm, tread with elastic (grey), ball bearing
- swivel-mounted & lockable door (lock not included)
- 1 intermediate shelf (only 5.1)
- recyclable plastic bottom
- color: blue galvanized



Available with plastic or steel bottom.



## SIEGEN

The **Siegen** is our larger version of the anti-theft nestainer® and enables an optimal transport of empties. Despite the size, the nestable function saves space. The container is available with the wire infill of 100 x 50 mm or 50 x 50 mm. If the supplied intermediate shelf is not enough for our purpose, you can add more at any time.

### Features:

- 5-sided nestainer®
- 2 swivel castors with brakes and 2 fixed castors, Ø 125 mm, tread with elastic (grey), ball bearing
- swivel-mounted & lockable door (lock not included)
- steel intermediate shelf (foldable to the back)
- available in the mesh size 100 x 50 mm & 50 x 50 mm



Easy handling, telescopic.

|  | Furth 5.0 Plastic Bottom   | Furth 5.1 Plastic Bottom  | Furth 5.0 Steel Bottom | Furth 5.1 Steel Bottom    |
|--|--|---------------------------|------------------------|---------------------------|
| Article number   | N5730815CC0Z446  | N5730815CC1Z146           | N5730815CC0Z246        | N5730815CC1Z046           |
| Composition  | 5-sided  |                           |                        |                           |
| Overall dimensions, W x D x H mm<br>Total height with Ø 125 mm castors | 728 x 823 x 1880   |                           |                        |                           |
| Internal dimensions (W x D x H mm)                                     | 670 x 773 x 1590   |                           | 670 x 773 x 1615       |                           |
| Payload  | 500 kg   |                           |                        |                           |
| Weight   | 69,4 kg  | 73,9 kg                   | 68,8 kg                | 73 kg                     |
| Mesh   | wire infill 50 x 50 mm, Ø 4 mm   |                           |                        |                           |
| Shelves  | optionally available   | 1 foldable shelf included | optionally available   | 1 foldable shelf included |
| Wheels   | 2 swivel castors with total brake and 2 fixed castors, Ø 125 mm, rim made of polyamide, tread made of elastic (grey), ball bearing |                           |                        |                           |
| Surface  | blue galvanized  |                           |                        |                           |

|  | Siegen 5.1 Steel Bottom  | Siegen 5.1 Steel Bottom (tight mesh) |
|--|--|--------------------------------------|
| Article number   | N58001200CC1Z053   | N58001200CC1Z153                     |
| Composition  | 5-sided  |                                      |
| Overall dimensions, W x D x H mm<br>Total height with Ø 125 mm castors | 1200 x 800 x 1820  |                                      |
| Internal dimensions (W x D x H mm)                                     | 1145 x 735 x 1545  |                                      |
| Payload  | 500 kg   |                                      |
| Weight   | 95 kg  | 103 kg                               |
| Mesh   | wire infill 100 x 50 mm, Ø 4 mm  | wire infill 50 x 50 mm, Ø 4 mm       |
| Shelves  | 1 shelf included   |                                      |
| Wheels   | 2 swivel castors with total brake and 2 fixed castors, Ø 125 mm, rim made of polyamide, tread made of elastic (grey), ball bearing |                                      |
| Surface  | blue galvanized  |                                      |





## KASSEL

Our ball trolley **Kassel** is characterized by a high ease of use. Its two loading doors allow an easy loading and unloading. If the ball trolley is not in use, it can be folded up to save space very comfortable. Quiet running swivel castors make transport additionally easier. The Kassel ball trolley can be expanded with additional accessories, e.g. compartment dividers.

### Features:

- 5-sided ball trolley
- 4 swivel castors Ø 100 mm, TPR tread
- foldable roof
- front wall with foldable opening
- foldable (in empty state)
- steel bottom 1040 x 610 mm
- color: blue galvanized

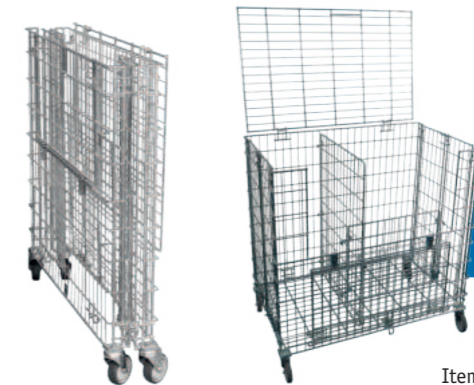

Further accessories are optionally available.

Items inside the product are not included.

|  | Kassel 5.0<br>Steel Bottom                  |
|--|---|
| Article number   | BW1040C032                                  |
| Composition  | 5-sided                                     |
| Overall dimensions, W x D x H mm<br>Total height with Ø 100 mm castors | 1040 x 610 x 1000                           |
| Internal dimensions (W x D x H mm)                                     | 950 x 585 x 870                             |
| Payload  | 150 kg                                      |
| Weight   | 30 kg                                       |
| Mesh   | wire infill 40 x 100 mm                     |
| Shelves  | not available                               |
| Wheels   | 4 swivel castors Ø 100 mm TPR, ball bearing |
| Surface  | blue galvanized                             |



## BOCHUM

Our anti-theft ball trolley **Bochum** stands out by its generous amount of space. The trolley offers plenty of space for the transport and storage of your goods due to the three or four equipped intermediate shelves with an upstand of 40 mm, the large wing doors and an optional basket structure. The tight set of steel mesh of the ball trolley protect your goods. The ball trolley is available with the heights of 1400 and 1700 mm.

### Features:

- 5-sided ball trolley (also possible with 3 or 4 sides)
- 2 swivel castors and 2 swivel castors with brakes, Ø 125 mm, elastic (grey), ball bearing
- intermediate shelves with an 40 mm upstand
- swivel-mounted and lockable wing-door (lock not included)
- steel bottom 1500 x 620 mm
- color: blue galvanized



Also as a 3- or 4-sided version possible.

|  | Bochum M 5.3<br>Steel Bottom   | Bochum M 5.3<br>(with basket)<br>Steel Bottom | Bochum L 5.4<br>Steel Bottom | Bochum M 5.3<br>(with basket)<br>Steel Bottom |
|--|--|---|------------------------------|---|
| Article number   | S56201500F03ZC053  | S56201500FA3ZC053                             | S56201500F04ZC153            | S56201500FA4ZC153                             |
| Composition  | 5-sided  |   |                              |   |
| Overall dimensions, W x D x H mm<br>Total height with Ø 125 mm castors | 1500 x 620 x 1400  | 1500 x 620 x 1550                             | 1500 x 620 x 1700            | 1500 x 620 x 1850                             |
| Internal dimensions (W x D x H mm)                                     | 1440 x 550 x 1190  |   | 1440 x 550 x 1490            |   |
| Payload  | 500 kg   |   |                              |   |
| Weight   | 87,1 kg  | 92,2 kg                                       | 99,6 kg                      | 104,7 kg                                      |
| Mesh   | wire infill 50 x 50 mm, Ø 4 mm   |   |                              |   |
| Shelves  | 3 shelves included   |   | 4 shelves included           |   |
| Wheels   | 2 swivel and 2 swivel castors with total brake Ø 125 mm elastic (grey), ball bearing |   |                              |   |
| Surface  | blue galvanized  |   |                              |   |







### RESIDENT LAUNDRY BAG

- material: 100 % Polyester, net weight of approx. 225 g/m<sup>2</sup>
- resident laundry bag, stable and safe transportation of laundry
- carrying strap and label tab
- can be used on both sides
- drawstring closure
- holds approx. 6 kg



| color         | 50 x 70 cm     |
|---------------|----------------|
| yellow/yellow | WG7500700B0LG1 |
| red/red       | WR7500700B0LR2 |
| blue/blue     | WB7500700B0LB3 |
| green/green   | WG7500700B0LG4 |



### ZIPPED LAUNDRY BAG

- material: 100 % Polyester, net weight of approx. 110 g/m<sup>2</sup>
- ideal for separate washing
- sturdy but particularly soft
- very gentle on the laundry



| color  | 40 x 60 cm    | 60 x 90 cm    | 80 x 130 cm    |
|--------|---------------|---------------|----------------|
| yellow | WG400600WNRG1 | WG600900WNRG1 | WG8001300WNRG1 |
| red    | WR400600WNR2  | WR600900WNR2  | WR8001300WNR2  |
| blue   | WB400600WNR3  | WB600900WNR3  | WB8001300WNR3  |
| green  | WG400600WNR4  | WG600900WNR4  | WG8001300WNR4  |
| white  | WW400600WNRW0 | WW600900WNRW0 | WW8001300WNRW0 |



### LAUNDRY CHANGING BAG

- material: 100 % Polyester, net weight of approx. 225 g/m<sup>2</sup>
- securely and eays transport
- quick-opening longitudinal opening
- toggle closure
- capacity of approx. 12.5 kg



| color         | 55 x 100 cm    |
|---------------|----------------|
| white/yellow  | WW5501000W0LG1 |
| white/red     | WW5501000W0LR2 |
| white/blue    | WW5501000W0LB3 |
| white/brown   | WW5501000W0LG5 |
| white/green   | WW5501000W0LG4 |
| white/gray    | WW5501000W0LG6 |
| brown/brown   | WB5501000W0LB5 |
| gray/gray     | WG5501000W0LG6 |
| yellow/yellow | WG5501000W0LG1 |
| red/red       | WR5501000W0LR2 |
| blue/blue     | WB5501000W0LB3 |
| green/green   | WG5501000W0LG4 |



### LAUNDRY BAG WITH DRAWSTRING FASTENER

- drawstring with a sliding lock
- material: 100 % Polyester, net weight of approx. 110 g/m<sup>2</sup>
- ideal for separate washing
- sturdy but particularly soft
- very gentle on the laundry



| color  | 40 x 60 cm    | 60 x 90 cm    | 80 x 130 cm    |
|--------|---------------|---------------|----------------|
| yellow | WG400600WNKG1 | WG600900WNKG1 | WG8001300WNKG1 |
| red    | WR400600WNKR2 | WR600900WNKR2 | WR8001300WNKR2 |
| blue   | WB400600WNKB3 | WB600900WNKB3 | WB8001300WNKB3 |
| green  | WG400600WNKG4 | WG600900WNKG4 | WG8001300WNKG4 |
| white  | WW400600WNKW0 | WW600900WNKW0 | WW8001300WNKW0 |



## LAUNDRY BAGS

Laundry bags are on the inside of the rolltainer® and are used for collecting dirty laundry. They protect the laundry from further dirt and damage and improve the appearance of the filled container.

**Fabric:**

- 100% polyester
- fabric ca. 220 g/m<sup>2</sup>
- thermofixed, durable, easy to clean

**Design:**

- toggle lock
- color: blue / white
- print of logo possible



Upon request: logo imprint in thermal printing process, washable.

| For Basic I       |                                    |                                    |
|-------------------|------------------------------------|------------------------------------|
| Article number    | WSB60072015200L<br>WSW60072015200L | WSB60072017300L<br>WSW60072017300L |
| Container size*   | 600 x 720 x 1520                   | 600 x 720 x 1730                   |
| Laundry bag size* | 555 x 720 x 1370                   | 555 x 720 x 1580                   |

| For Premium I     |                                    |                                    |                                    |
|-------------------|------------------------------------|------------------------------------|------------------------------------|
| Article number    | WSB60074011500L<br>WSW60074011500L | WSB60074013500L<br>WSW60074013500L | WSB60074015200L<br>WSW60074015200L |
| Container size*   | 600 x 740 x 1150                   | 600 x 740 x 1350                   | 600 x 740 x 1520                   |
| Laundry bag size* | 555 x 735 x 1000                   | 555 x 735 x 1200                   | 555 x 735 x 1370                   |

| For Premium II    |                                    |                                    |                                    |
|-------------------|------------------------------------|------------------------------------|------------------------------------|
| Article number    | WSB60081013500L<br>WSW60081013500L | WSB60081015200L<br>WSW60081015200L | WSB60081017000L<br>WSW60081017000L |
| Container size*   | 600 x 810 x 1350                   | 600 x 810 x 1520                   | 600 x 810 x 1700                   |
| Laundry bag size* | 555 x 800 x 1200                   | 555 x 800 x 1370                   | 555 x 800 x 1550                   |

| For Basic II and Premium III |                                    |                                    |                                    |                                    |                                    |
|------------------------------|------------------------------------|------------------------------------|------------------------------------|------------------------------------|------------------------------------|
| Article number               | WSB72081011500L<br>WSW72081011500L | WSB72081013500L<br>WSW72081013500L | WSB72081015200L<br>WSW72081015200L | WSB72081017000L<br>WSW72081017000L | WSB72081018000L<br>WSW72081018000L |
| Container size*              | 720 x 810 x 1150                   | 720 x 810 x 1350                   | 720 x 810 x 1520                   | 720 x 810 x 1700                   | 720 x 810 x 1800                   |
| Laundry bag size*            | 675 x 800 x 1000                   | 675 x 800 x 1200                   | 675 x 800 x 1370                   | 675 x 800 x 1550                   | 675 x 800 x 1650                   |

\*Overall dimensions (W x D x H mm)



## COVER HOODS

Cover hoods are used for the transport of clean laundry in laundry containers and are fixed on the outside. They are mainly used for distributing clean laundry and protect them from dirt and damage.

**Fabric:**

- 100% polyester
- fabric ca. 220 g/m<sup>2</sup>
- thermofixed, durable, easy to clean

**Design:**

- toggle lock
- color: blue / white
- print of logo possible



Upon request: logo imprint in thermal printing process, washable.

| For Basic I       |                                    |                                    |
|-------------------|------------------------------------|------------------------------------|
| Article number    | AHB60072015200L<br>AHW60072015200L | AHB60072017300L<br>AHW60072017300L |
| Container size*   | 600 x 720 x 1520                   | 600 x 720 x 1730                   |
| Laundry bag size* | 600 x 720 x 1392                   | 600 x 720 x 1602                   |

| For Premium I     |                                    |                                    |                                    |
|-------------------|------------------------------------|------------------------------------|------------------------------------|
| Article number    | AHB60074011500L<br>AHW60074011500L | AHB60074013500L<br>AHW60074013500L | AHB60074015200L<br>AHW60074015200L |
| Container size*   | 600 x 740 x 1150                   | 600 x 740 x 1350                   | 600 x 740 x 1520                   |
| Laundry bag size* | 600 x 740 x 1022                   | 600 x 740 x 1222                   | 600 x 740 x 1392                   |

| For Premium II    |                                    |                                    |                                    |
|-------------------|------------------------------------|------------------------------------|------------------------------------|
| Article number    | AHB60081013500L<br>AHW60081013500L | AHB60081015200L<br>AHW60081015200L | AHB60081017000L<br>AHW60081017000L |
| Container size*   | 600 x 810 x 1350                   | 600 x 810 x 1520                   | 600 x 810 x 1700                   |
| Laundry bag size* | 600 x 810 x 1222                   | 600 x 810 x 1392                   | 600 x 810 x 1572                   |

| For Basic II and Premium III |                                    |                                    |                                    |                                    |                                    |
|------------------------------|------------------------------------|------------------------------------|------------------------------------|------------------------------------|------------------------------------|
| Article number               | AHB72081011500L<br>AHW72081011500L | AHB72081013500L<br>AHW72081013500L | AHB72081015200L<br>AHW72081015200L | AHB72081017000L<br>AHW72081017000L | AHB72081018000L<br>AHW72081018000L |
| Container size*              | 720 x 810 x 1150                   | 720 x 810 x 1350                   | 720 x 810 x 1520                   | 720 x 810 x 1700                   | 720 x 810 x 1800                   |
| Laundry bag size*            | 720 x 810 x 1022                   | 720 x 810 x 1222                   | 720 x 810 x 1392                   | 720 x 810 x 1572                   | 720 x 810 x 1672                   |





## DOCUMENT FRAMES

- for DIN A4, A5 and A6
- loose, variable plugged or screwed
- surface: blue galvanized

|                     | A4     | A5     | A6     |
|---------------------|--------|--------|--------|
| plugged, vertical   | DHGA4B | DHGA5B | DHGA6B |
| plugged, horizontal | DQGA4B | DQGA5B | DQGA6B |
| screwed, vertical   | DHGA4B | DHGA5B | DHGA6B |
| screwed, horizontal | DQGA4B | DQGA5B | DQGA6B |

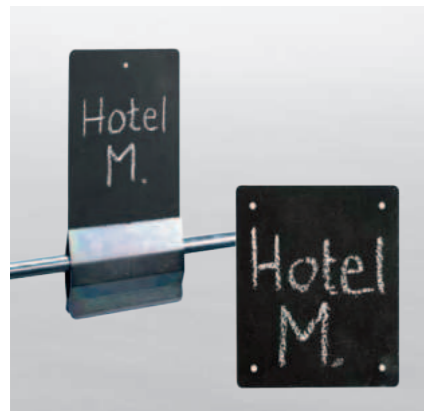

## CLIP-ON BOARD

- dimension DIN A5
- loose, variably attachable
- writable surface

## LABEL PANEL

- dimension 150 x 140 mm
- writable surface

|                | Clip-On board         | Label panel  |
|----------------|-----------------------|--------------|
| Article number | AHGBA5B               | BB150140B    |
| Dimension      | 148 x 210 mm (DIN A5) | 150 x 140 mm |



## CLOTHES RAIL (SCREWABLE)

- for laundry container
- loose, variably attachable
- surface: blue galvanized

| For laundry container | Basic I<br>Premium I/II | Basic II<br>Premium III | Bremen<br>Bern | Bonn    |
|-----------------------|-------------------------|-------------------------|----------------|---------|
| Article number        | WKS600B                 | WKS720B                 | WKS850B        | WKS940B |
| Dimension             | 570 mm                  | 690 mm                  | 825 mm         | 880 mm  |
| Weight                | 0,50 kg                 | 0,60 kg                 | 0,68 kg        | 0,74 kg |

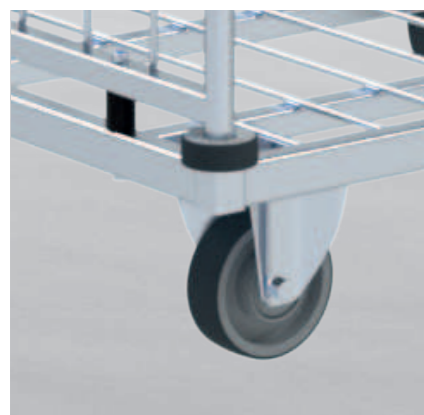

## BUMPER WHEELS

Wheel rim made of polypropylene with a tread made of thermoplastic elastomer (95° Shore A) in grey.

| For laundry container | Basic 3.0<br>Premium 3.0 | Basic 4.0<br>Premium 4.0 |
|-----------------------|--------------------------|--------------------------|
| Article number        | AWRBP3                   | AWRBP4                   |
| Outer diameter        | Ø 50 mm                  | Ø 50 mm                  |
| Inside diameter       | Ø 22 mm                  | Ø 22 mm                  |
| Weight                | 0,03 kg                  | 0,03 kg                  |



## SWITCHING SYSTEM

Our predicted switching system is a smart 2-in-1 solution that enables easy handling. You can switch between two swivel castors and two fixed castors on four swivel castors with just one click. The user benefits from easier handling. In addition, you can counteract a transverse gear.



| For laundry container | Basic I<br>Premium I/II | Basic II<br>Premium III | Bremen<br>Bern | Bonn        |
|-----------------------|-------------------------|-------------------------|----------------|-------------|
| Article number        | US450TPE100             | US570TPE100             | US480TPE100    | US400TPE100 |
| Dimension             | 450 mm                  | 570 mm                  | 480 mm         | 400 mm      |

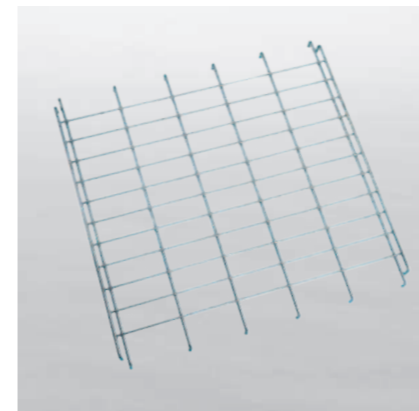

## STEEL INTERMEDIATE SHELF ATTACHABLE

- for laundry container Basic and Premium
- loose, variably attachable
- steel grid: blue galvanized

| Article number    | ZBSL600720B  | ZBSL600740B  | ZBSL600810B  | ZBSL720810B  |
|-------------------|--------------|--------------|--------------|--------------|
| Dimension (B x T) | 611 x 660 mm | 606 x 670 mm | 606 x 740 mm | 726 x 740 mm |
| Weight            | 2,1 kg       | 2,1 kg       | 2,3 kg       | 3,9 kg       |
| Payload           | 150 kg       |              |              |              |



## STEEL INTERMEDIATE SHELF FOLDABLE

- for laundry container Basic and Premium
- fixed and foldable
- steel grid: blue galvanized

| Article number    | ZBSK600720BU | ZBSK600740BU | ZBSK600810BU | ZBSK720810BU |
|-------------------|--------------|--------------|--------------|--------------|
| Dimension (B x T) | 615 x 660 mm | 610 x 670 mm | 610 x 740 mm | 730 x 740 mm |
| Weight            | 3,0 kg       | 3,1 kg       | 3,4 kg       | 3,6 kg       |
| Payload           | 150 kg       |              |              |              |



## STEEL INTERMEDIATE SHELF FOLDABLE, NAP STRUCTURE PLATE

- for laundry container Basic and Premium
- fixed and foldable
- with a 5 mm nap structure plate in white
- steel grid: blue galvanized

| Article number    | ZBSKK600720B | ZBSKK600740B | ZBSKK600810B | ZBSKK720810B |
|-------------------|--------------|--------------|--------------|--------------|
| Dimension (B x T) | 615 x 660 mm | 610 x 670 mm | 610 x 740 mm | 730 x 740 mm |
| Weight            | 3,4 kg       | 3,4 kg       | 3,8 kg       | 4,0 kg       |
| Payload           | 150 kg       |              |              |              |

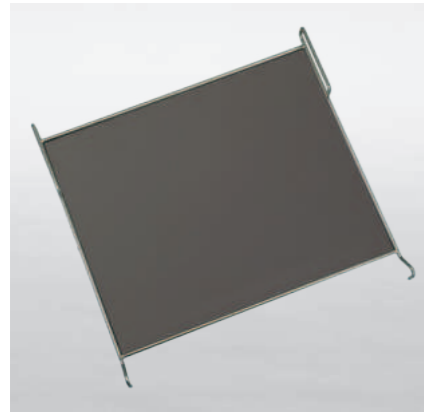

## INTERMEDIATE SHELF FOLDABLE, PHENOLIC RESIN PLATE

- for laundry container Basic and Premium
- fixed and foldable
- with a 4 mm phenolic resin plate
- steel grid: blue galvanized

| Article number    | ZBSKH600720B | ZBSKH600740B | ZBSKH600810B | ZBSKH720810B |
|-------------------|--------------|--------------|--------------|--------------|
| Dimension (B x T) | 615 x 660 mm | 610 x 670 mm | 610 x 670 mm | 730 x 740 mm |
| Weight            | 4,0 kg       | 4,0 kg       | 4,4 kg       | 4,6 kg       |
| Payload           | 150 kg       |              |              |              |

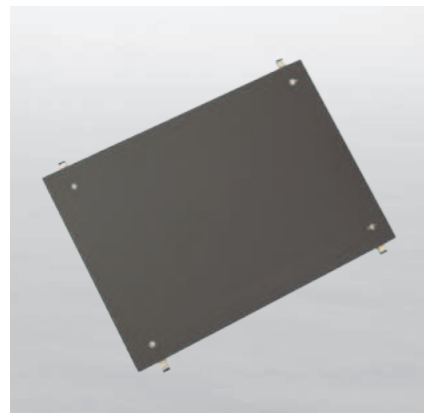

## INTERMEDIATE SHELF WITH PHENOLIC RESIN PLATE

- for laundry container Basic and Premium
- loose, variably attachable
- with a 8 mm phenolic resin plate
- steel grid: blue galvanized

| Article number    | ZBSH600720B  | ZBSH600740B  | ZBSH600810B  | ZBSH720810B  |
|-------------------|--------------|--------------|--------------|--------------|
| Dimension (B x T) | 615 x 660 mm | 610 x 670 mm | 610 x 670 mm | 730 x 740 mm |
| Weight            | 3,2 kg       | 3,2 kg       | 3,4 kg       | 4,1 kg       |
| Payload           | 150 kg       |              |              |              |

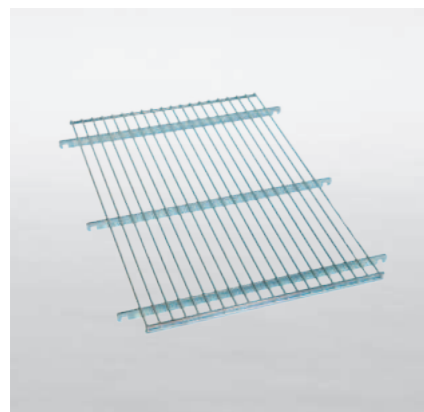

## WIRE MESH INTERMEDIATE SHELF WITHOUT/ WITH UPSTAND

- for rolltainer® with the bottom size of 460 x 620 mm
- loose, variably attachable
- surface: blue galvanized

| Article number    | ZD4600RKFC001   | ZD460MRKFC001       |
|-------------------|-----------------|---------------------|
| Dimension (B x T) | 460 x 640 mm    | 460 x 640 x 100 mm  |
| Weight            | 2,5 kg          | 2,8 kg              |
| Payload           | 150 kg          |                     |
| Upstand           | without upstand | with 100 mm upstand |



## WIRE MESH INTERMEDIATE SHELF WITH UPSTAND

- for rolltainer® with the bottom size of 600 x 600 mm
- loose, variably attachable
- surface: blue galvanized

| Article number    | ZD600MRKFC001      | ZD600MRKFC002       |
|-------------------|--------------------|---------------------|
| Dimension (B x T) | 600 x 600 x 20 mm  | 600 x 600 x 100 mm  |
| Weight            | 3 kg               | 3,4 kg              |
| Payload           | 150 kg             |                     |
| Upstand           | with 20 mm upstand | with 100 mm upstand |



## WIRE MESH INTERMEDIATE SHELF WITHOUT UPSTAND

- for laundry and rolltainer® with the bottom size of 1200 x 800 mm
- loose, variably attachable
- surface: blue galvanized

| Article number    | ZD12000RKFC001 |
|-------------------|----------------|
| Dimension (B x T) | 1200 x 800 mm  |
| Weight            | 5,8 kg         |
| Payload           | 150 kg         |



## WIRE MESH INTERMEDIATE SHELF WITH 20 MM UPSTAND

- for laundry and rolltainer® with the bottom size of 1200 x 800 mm
- loose, variably attachable
- surface: blue galvanized

| Article number    | ZD1200MRKFC001     |
|-------------------|--------------------|
| Dimension (B x T) | 1200 x 800 x 20 mm |
| Weight            | 5,9 kg             |
| Payload           | 150 kg             |



## WIRE MESH INTERMEDIATE SHELF WITH 20 MM UPSTAND, ATTACHABLE WITH ANGLE

- for laundry and rolltainer® with the bottom size of 1200 x 800 mm
- loose, attachable in various angle
- surface: blue galvanized

| Article number    | ZD1200SRKFC001     |
|-------------------|--------------------|
| Dimension (B x T) | 1200 x 800 x 20 mm |
| Weight            | 6,9 kg             |
| Payload           | 150 kg             |



## WIRE MESH INTERMEDIATE SHELF WITHOUT UPSTAND

- for rolltainer® with the bottom size of 1350 x 950 mm
- loose, variably attachable
- surface: blue galvanized

| Article number    | ZD13500RKFC001 |
|-------------------|----------------|
| Dimension (B x T) | 1350 x 950 mm  |
| Weight            | 15,4 kg        |
| Payload           | 200 kg         |





### PLASTIC INTERMEDIATE SHELF

- FOR THE SIZE 682 X 815 MM, LOOSE, VARIABLY ATTACHABLE**
- different intermediate shelves for 2- and 3-sided rolltainer®
  - reinforced with 3 flat irons
  - color: gentian blue similar to RAL 5010

| Article number      | E70B02PEF35010 | E70B03PEF35010 |
|---------------------|----------------|----------------|
| Dimension (B x T)   | 620 x 810 mm   | 620 x 760 mm   |
| Roll container type | 2-sided        | 3-sided        |
| Payload             | 3 kg           |                |
| Upstand             | 150 kg         |                |



### PLASTIC INTERMEDIATE SHELF FOR THE SIZE 714 X 815 MM

- different intermediate shelves for 2-, 3- and 4-sided laundry container
- reinforced with 3 flat irons
- color: gentian blue similar to RAL 5010

| Article number      | E70A23PEF35010 | E70A04PEF35010 |
|---------------------|----------------|----------------|
| Dimension (B x T)   | 710 x 760 mm   | 710 x 710 mm   |
| Roll container type | 2- & 3-sided   | 4-sided        |
| Payload             | 3 kg           |                |
| Upstand             | 150 kg         |                |



### WIRE MESH INTERMEDIATE SHELF

- for 2-, 3- and 4-sided roll, laundry and anti-theft container with the bottom size of 724 x 815 mm
- loose, variably attachable
- surface: blue galvanized

| Article number    | ZBD725ADLC004 |
|-------------------|---------------|
| Dimension (B x T) | 720 x 810 mm  |
| Weight            | 4,2 kg        |
| Payload           | 150 kg        |



### WIRE INTERMEDIATE SHELF

- for 2-, 3- and 4-sided roll and anti-theft container with the bottom size of 682 x 815 mm
- loose, variably attachable
- surface: blue galvanized

| Article number    | ZBD682ADLC008 |
|-------------------|---------------|
| Dimension (B x T) | 680 x 810 mm  |
| Weight            | 4,2 kg        |
| Payload           | 150 kg        |



### TEXTILE STRAP WITH ELASTIC RUBBER

- 2 wire hooks
- black/ grey
- for container up to 750 mm width

| Article number        | E150001BL   |
|-----------------------|-------------|
| Dimension (B x T)     | 520 x 50 mm |
| Max. recommended span | 750 mm      |



### TEXTILE STRAP WITH ELASTIC RUBBER

- 1 wire hook/ 1 wire loop
- black/ grey
- for container up to 750 mm width

| Article number        | E150002BL   |
|-----------------------|-------------|
| Dimension (B x T)     | 560 x 50 mm |
| Max. recommended span | 750 mm      |



### TEXTILE STRAP WITH POLYPROPYLENE

- 1 round wire hook/ 1 clamp lock
- blue, red, yellow, black
- for container up to 800 mm width

| Article number        | E459945      | E459941      | E459940      | E459943      |
|-----------------------|--------------|--------------|--------------|--------------|
| Color                 | blue         | red          | yellow       | black        |
| Dimension (B x T)     | 1050 x 25 mm | 1050 x 25 mm | 1050 x 25 mm | 1050 x 25 mm |
| Max. recommended span | 800 mm       | 800 mm       | 800 mm       | 800 mm       |

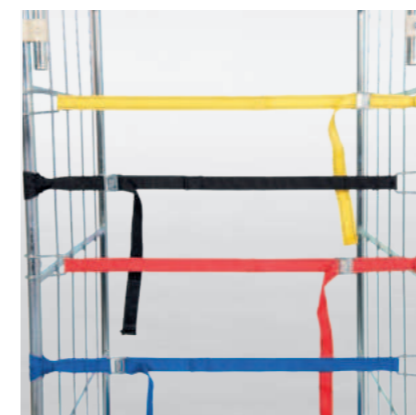

### TEXTILE STRAP WITH POLYPROPYLENE WITH ELASTIC

- 1 round wire hook/ 1 clamp lock
- blue, red, yellow, black
- for container up to 800 mm width

| Article number        | E459965      | E459961      | E459960      | E459966      |
|-----------------------|--------------|--------------|--------------|--------------|
| Color                 | blue         | red          | yellow       | black        |
| Dimension (B x T)     | 1050 x 25 mm | 1050 x 25 mm | 1050 x 25 mm | 1050 x 25 mm |
| Max. recommended span | 800 mm       | 800 mm       | 800 mm       | 800 mm       |



## ELASTIC STRAP

- 2 wire hooks
- black
- for container up to 750 mm width

|                       |             |
|-----------------------|-------------|
| Article number        | B454001     |
| Dimension (B x T)     | 480 x 37 mm |
| Max. recommended span | 750 mm      |



## ELASTIC STRAP

- 1 wire hook/ 1 loop
- black
- for container up to 750 mm width

|                       |             |
|-----------------------|-------------|
| Article number        | B454002     |
| Dimension (B x T)     | 400 x 37 mm |
| Max. recommended span | 750 mm      |



## ELASTIC STRAP

- 1 metal peg/ 1 metal loop
- grey
- for container up to 800 mm width

|                       |             |
|-----------------------|-------------|
| Article number        | B454501     |
| Dimension (B x T)     | 485 x 40 mm |
| Max. recommended span | 800 mm      |



## ELASTIC STRAP

- 1 metal peg/ 1 metal loop
- grey
- for container up to 900 mm width

|                       |             |
|-----------------------|-------------|
| Article number        | B456302     |
| Dimension (B x T)     | 640 x 30 mm |
| Max. recommended span | 900 mm      |



## ELASTIC STRAP

- 1 metal peg/ 1 metal loop
- grey
- for container up to 1100 mm width

|                       |             |
|-----------------------|-------------|
| Article number        | B457503     |
| Dimension (B x T)     | 780 x 40 mm |
| Max. recommended span | 1100 mm     |



## TECHNICAL GUIDE

### Castor definition

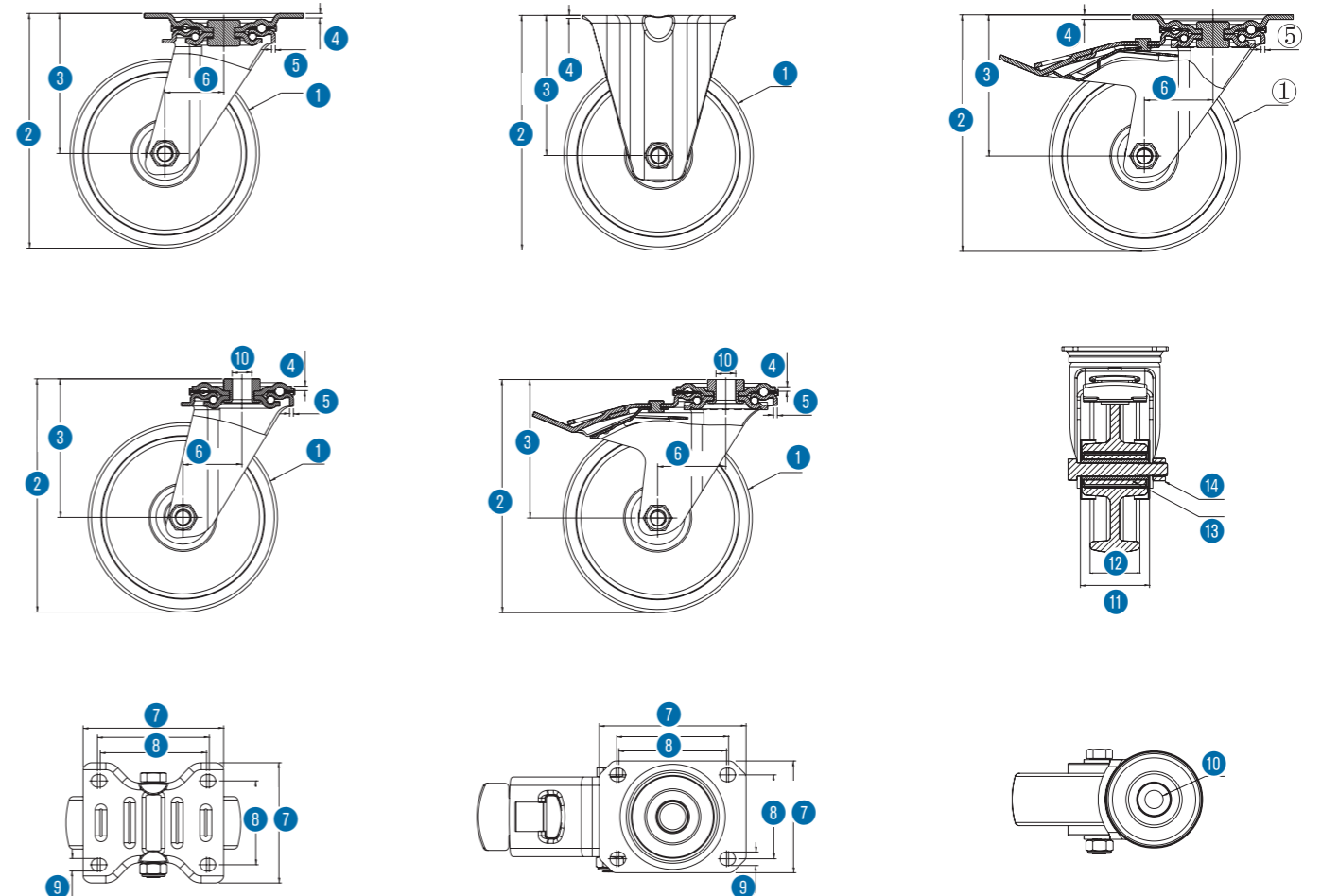





- ① wheel diameter
- ② total height
- ③ mounting height
- ④ material thickness plate
- ⑤ material thickness fork
- ⑥ offset
- ⑦ dimension of plate
- ⑧ dimension of plate holes
- ⑨ diameter of plate holes
- ⑩ diameter of bolt hole
- ⑪ width of tread
- ⑫ width of hub
- ⑬ wheel bearing
- ⑭ screw size







THE RIGHT CHOICE of castors:









## HOUSING

-  wheel diameter  
in mm
-  external dimension mounting plate  
in mm
-  mounting dimension  
in mm
-  hole diameter  
in mm



-  offset dimension  
in mm
-  total height  
in mm
-  swivel radius  
in mm
-  dyn. load capacity  
in kg

## WHEEL.

-  wheel diameter  
in mm
-  tread width  
in mm
-  hub width  
in mm

-  bushing diameter  
in mm
-  screw size  
in mm
-  dyn. load capacity  
in kg





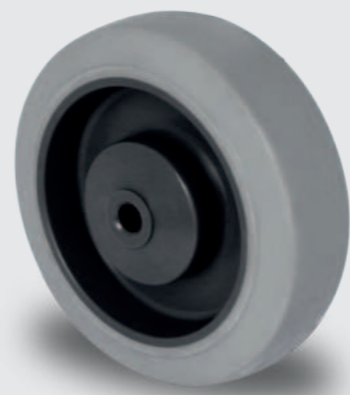





## WHEELS BEARINGS



-  single ball bearing
-  double ball bearing













### SERIE P2D2

rim: polypropylene  
 tread: thermoplastic rubber 65° shore A grey  
 axle bearing: ball bearing  
 threadguard: small plastic threadguard  
 load capacity: 135 kg to 165 kg  
 wheel diameter: 100 mm to 125 mm  
 temperature range: -20°C to +60°C

|                   |  |  |  |  |  |  |  |  |  |
|-------------------|---|---|---|---|---|---|---|---|--|
|                   | [mm]  | [mm]  | [mm]  | [mm]  | [mm]  | [mm]  | [mm]  | [kg]  |  |
| swivel castor     |   |   |   |   |   |   |   |   |  |
| SBP26WC100P2D2B32 |  | 100   | 105x80  | 80/77x60  | 9   | 40  | 125   | 135   |  |
| SBP35WC125P2D2B32 |  | 125   | 105x80  | 80/77x60  | 9   | 40  | 155   | 165   |  |

|                   |   |     |        |          |   |  |     |     |  |
|-------------------|---|-----|--------|----------|---|--|-----|-----|--|
| fixed castor      |   |     |        |          |   |  |     |     |  |
| FBP22WC100P2D2B32 |  | 100 | 105x80 | 80/77x60 | 9 |  | 125 | 135 |  |
| FBP32WC125P2D2B32 |  | 125 | 105x80 | 80/77x60 | 9 |  | 155 | 165 |  |

|                                |   |     |        |          |   |    |     |     |     |
|--------------------------------|---|-----|--------|----------|---|----|-----|-----|-----|
| swivel castor with total brake |   |     |        |          |   |    |     |     |     |
| TBP25WC100P2D2B32              |  | 100 | 105x80 | 80/77x60 | 9 | 40 | 125 | 127 | 135 |
| TBP35WC125P2D2B32              |  | 125 | 105x80 | 80/77x60 | 9 | 45 | 155 | 127 | 165 |

|              |  |  |  |  |  |  |  |
|--------------|---|---|---|---|---|---|---|
|              | [mm]  | [mm]  | [mm]  | [mm]  | Ø   |   | [kg]  |
| single wheel |   |   |   |   |   |   |   |
| 100P2D2B32   |  | 100   | 35  | 40  | 8   | M8  | 135   |
| 125P2D2B32   |  | 125   | 40  | 50  | 10  | M10   | 165   |





### SERIE POPO

rim: polypropylene  
 tread: polypropylene  
 axle bearing: plain bearing / roller bearing  
 threadguard: without / small metal threadguard  
 load capacity: 100 kg to 150 kg  
 wheel diameter: 100 mm to 125 mm  
 temperature range: -20°C to +60°C



### SERIE R4E2

rim: polyamide  
 tread: elastic 65° shore A grey  
 axle bearing: ball bearing  
 threadguard: small plastic threadguard  
 load capacity: 200 kg to 250 kg  
 wheel diameter: 100 mm to 125 mm  
 temperature range: -20°C to +80°C

|                   | [mm] | [mm]   | [mm]     | [mm] | [mm] | [mm] | [kg] |
|-------------------|------|--------|----------|------|------|------|------|
| swivel castor     |      |        |          |      |      |      |      |
| SBP25WC100POPOR1W | 100  | 105x80 | 80/77x60 | 9    | 40   | 125  | 100  |
| SBP25WC108POPOR1W | 108  | 105x80 | 80/77x60 | 9    | 40   | 132  | 150  |
| SBP35WC125POPOR1W | 125  | 105x80 | 80/77x60 | 9    | 40   | 155  | 150  |



|                   | [mm] | [mm]   | [mm]     | [mm] | [mm] | [mm] | [kg] |
|-------------------|------|--------|----------|------|------|------|------|
| fixed castor      |      |        |          |      |      |      |      |
| FBP22WC100POPOR1W | 100  | 105x80 | 80/77x60 | 9    |      | 125  | 100  |
| FBP22WC108POPOR1W | 108  | 105x80 | 80/77x60 | 9    |      | 132  | 150  |
| FBP32WC125POPOR1W | 125  | 105x80 | 80/77x60 | 9    |      | 155  | 150  |



|                                | [mm] | [mm]   | [mm]     | [mm] | [mm] | [mm] | [kg] |     |
|--------------------------------|------|--------|----------|------|------|------|------|-----|
| swivel castor with total brake |      |        |          |      |      |      |      |     |
| TBP25WC100POPOR1W              | 100  | 105x80 | 80/77x60 | 9    | 40   | 125  | 127  | 100 |
| TBP25WC108POPOR1W              | 108  | 105x80 | 80/77x60 | 9    | 40   | 132  | 127  | 150 |
| TBP35WC125POPOR1W              | 125  | 105x80 | 80/77x60 | 9    | 45   | 155  | 127  | 150 |



|              | [mm] | [mm] | [mm] | [mm] | ∅   |  | [kg] |
|--------------|------|------|------|------|-----|--|------|
| single wheel |      |      |      |      |     |  |      |
| 100POPOR1W   | 100  | 36   | 40   | 12   | M8  |  | 100  |
| 108POPOR1W   | 108  | 36   | 40   | 12   | M8  |  | 150  |
| 125POPOR1W   | 125  | 38   | 50   | 15   | M10 |  | 150  |



|                   | [mm] | [mm]   | [mm]     | [mm] | [mm] | [mm] | [kg] |
|-------------------|------|--------|----------|------|------|------|------|
| swivel castor     |      |        |          |      |      |      |      |
| SPP21WC100R4E2B34 | 100  | 105x80 | 80/77x60 | 9    | 40   | 128  | 200  |
| SPP31WC125R4E2B34 | 125  | 105x80 | 80/77x60 | 9    | 40   | 155  | 220  |



|                   | [mm] | [mm]   | [mm]     | [mm] | [mm] | [mm] | [kg] |
|-------------------|------|--------|----------|------|------|------|------|
| fixed castor      |      |        |          |      |      |      |      |
| FPP22WC100R4E2B34 | 100  | 105x80 | 80/77x60 | 9    |      | 128  | 200  |
| FPP35WC125R4E2B34 | 125  | 105x80 | 80/77x60 | 9    |      | 155  | 220  |



|                                | [mm] | [mm]   | [mm]     | [mm] | [mm] | [mm] | [kg] |     |
|--------------------------------|------|--------|----------|------|------|------|------|-----|
| swivel castor with total brake |      |        |          |      |      |      |      |     |
| TPP21WC100R4E2B34              | 100  | 105x80 | 80/77x60 | 9    | 40   | 128  | 127  | 200 |
| TPP31WC125R4E2B34              | 125  | 105x80 | 80/77x60 | 9    | 45   | 155  | 127  | 220 |



|              | [mm] | [mm] | [mm] | [mm] | ∅   |  | [kg] |
|--------------|------|------|------|------|-----|--|------|
| single wheel |      |      |      |      |     |  |      |
| 100R4E2B34   | 100  | 35   | 40   | 8    | M8  |  | 200  |
| 125R4E2B34   | 125  | 38   | 50   | 10   | M10 |  | 250  |





### SERIE N2U6

rim: polyamide  
 tread: thermoplastic polyurethane 95° shore A red  
 axle bearing: ball bearing  
 threadguard: small metal / plastic threadguard  
 load capacity: 150 kg to 200 kg  
 wheel diameter: 100 mm to 200 mm  
 temperature range: -40°C to +80°C



### SERIE POPO

rim: polypropylene  
 tread: polypropylene  
 axle bearing: ball bearing  
 threadguard: big metal threadguard  
 load capacity: 150 kg  
 wheel diameter: 108 mm  
 temperature range: -20°C to +60°C



swivel castor

|                   | [mm] | [mm] | [mm]   | [mm]     | [mm] | [mm] | [mm] | [kg] |
|-------------------|------|------|--------|----------|------|------|------|------|
| SPP21WC100N2U6B32 |      | 100  | 105x80 | 80/77x60 | 9    | 40   | 128  | 150  |
| SPP31WC125N2U6B32 |      | 125  | 105x80 | 80/77x60 | 9    | 40   | 155  | 200  |



fixed castor

|                   |  |     |        |          |   |  |     |     |
|-------------------|--|-----|--------|----------|---|--|-----|-----|
| FPP25WC100N2U6B32 |  | 100 | 105x80 | 80/77x60 | 9 |  | 128 | 150 |
| FPP35WC125N2U6B32 |  | 125 | 105x80 | 80/77x60 | 9 |  | 155 | 200 |



swivel castor with total brake

|                   |  |     |        |          |   |    |     |     |     |
|-------------------|--|-----|--------|----------|---|----|-----|-----|-----|
| TPP21WC100N2U6B32 |  | 100 | 105x80 | 80/77x60 | 9 | 40 | 128 | 127 | 150 |
| TPP31WC125N2U6B32 |  | 125 | 105x80 | 80/77x60 | 9 | 45 | 155 | 127 | 200 |



single wheel

|            | [mm] | [mm] | [mm] | [mm] | ∅  |     | [kg] |
|------------|------|------|------|------|----|-----|------|
| 100N2U6B32 |      | 100  | 32   | 40   | 8  | M8  | 150  |
| 125N2U6B32 |      | 125  | 32   | 50   | 10 | M10 | 200  |



swivel castor

|                   | [mm] | [mm] | [mm]   | [mm]  | [mm] | [mm] | [mm] | [kg] |
|-------------------|------|------|--------|-------|------|------|------|------|
| SBP25WC108P0P0R2W |      | 108  | 105x80 | 80x60 | 9    | 40   | 132  | 150  |

fixed castor

|                   |  |     |        |       |   |    |     |     |
|-------------------|--|-----|--------|-------|---|----|-----|-----|
| SBP25WC108P0P0R2W |  | 108 | 105x80 | 80x60 | 9 | 40 | 132 | 150 |
|-------------------|--|-----|--------|-------|---|----|-----|-----|



### CASTORS FOR THE SWITCHING SYSTEM

Rim: polypropylene/ polyamide  
 Bearing: single ball bearing  
 Threadguard: small plastic threadguard  
 load capacity: 135 kg to 220 kg  
 wheel diameter: 100 mm to 125 mm  
 temperature range: -20°C (-40°C) to +80°C



|                      |  | [mm] | [mm]   | [mm]     | [mm] | [mm] | [mm] | [mm] | [kg] |
|----------------------|--|------|--------|----------|------|------|------|------|------|
| DIRSPP21WC100P2D2B32 | Thermoplastic rubber 65° Shore A       | 100  | 105x80 | 80/77x60 | 9    | 40   | 128  | 127  | 135  |
| DIRSPP31WC125P2D2B32 | Thermoplastic rubber 65° Shore A       | 125  | 105x80 | 80/77x60 | 9    | 40   | 155  | 127  | 165  |
| DIRSPP21WC100R4E2B34 | Elastic grey 65° Shore A               | 100  | 105x80 | 80/77x60 | 9    | 40   | 128  | 127  | 200  |
| DIRSPP31WC125R4E2B34 | Elastic grey 65° Shore A               | 125  | 105x80 | 80/77x60 | 9    | 40   | 155  | 127  | 220  |
| DIRSPP21WC100N2U6B32 | Thermoplastic polyurethane 95° Shore A | 100  | 105x80 | 80/77x60 | 9    | 40   | 128  | 127  | 150  |
| DIRSPP31WC125N2U6B32 | Thermoplastic polyurethane 95° Shore A | 125  | 105x80 | 80/77x60 | 9    | 40   | 155  | 127  | 200  |





**Seewald**  
Transportgeräte

**WE ARE HAPPY  
TO ADVISE YOU**

CONTACT US:

**+49 8861 9309248**

**SEEWALD TRANSPORTGERÄTE GMBH**

August-Moralt-Str. 1-3 | 86971 Peiting | Germany

[www.seewald-transportgeraete.de](http://www.seewald-transportgeraete.de)  
[info@seewald-transportgeraete.de](mailto:info@seewald-transportgeraete.de)

